

RICOH

AficioTM AP3800C

Operating Instructions Maintenance Guide

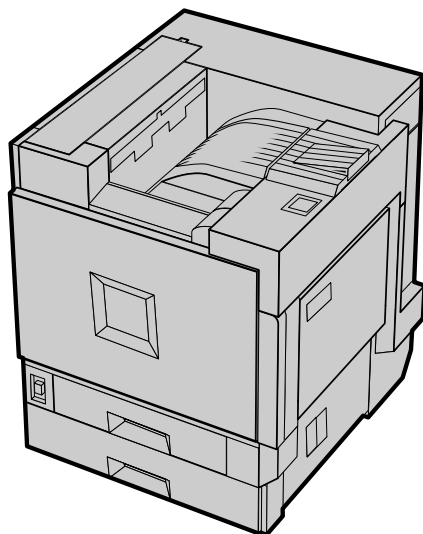

For safety, please read this manual carefully before you use this product and keep it handy for future reference.

Introduction

This manual describes detailed instructions on the operation and notes about the use of this machine. To get maximum versatility from this machine all operators are requested to read this manual carefully and follow the instructions. Please keep this manual in a handy place near the machine.

Trademarks

Microsoft, Windows and Windows NT are registered trademarks of Microsoft Corporation in the United States and/or other countries.

IPS-PRINT Printer Language Emulation Copyright© 1999-2000 Oak Technology, Inc., All rights reserved.

Other product names used herein are for identification purposes only and might be trademarks of their respective companies. We disclaim any and all rights in those marks.

Notes:

Some illustrations in this manual might be slightly different from the machine. Certain options might not be available in some countries. For details, please contact your local dealer.

Note

The proper names of the Windows operating systems are as follows:

- Microsoft® Windows® 95 operating system
- Microsoft® Windows® 98 operating system
- Microsoft® Windows® Millennium Edition (Windows Me)
- Microsoft® Windows® 2000 Professional
- Microsoft® Windows® 2000 Server
- Microsoft® Windows® XP Professional
- Microsoft® Windows® XP Home Edition
- Microsoft® Windows NT® Server operating system Version 4.0
- Microsoft® Windows NT® Workstation operating system Version 4.0

Safety Information

When using your printer, the following safety precautions should always be followed.

Safety During Operation

In this manual, the following important symbols are used:

- | |
|--|
| <p>⚠ WARNING:
<i>Indicates a potentially hazardous situation which, if instructions are not followed, could result in death or serious injury.</i></p> <p>⚠ CAUTION:
<i>Indicates a potentially hazardous situation which, if instructions are not followed, may result in minor or moderate injury or damage to property.</i></p> |
|--|

⚠ WARNING:

- | |
|--|
| <ul style="list-style-type: none">• Disconnect the power plug (by pulling the plug, not the cable) if the power cable or plug becomes frayed or otherwise damaged.• To avoid hazardous electric shock or laser radiation exposure, do not remove any covers or screws other than those specified in this manual.• Turn off the power and disconnect the power plug (by pulling the plug, not the cable) if any of the following conditions exists:<ul style="list-style-type: none">• You spill something into the equipment.• You suspect that your equipment needs service or repair.• Your equipment's cover has been damaged.• Do not incinerate spilled toner or used toner. Toner dust might ignite when exposed to an open flame.• Disposal can take place at our authorized dealer or at appropriate collection sites.• Dispose of the used toner cartridge in accordance with the local regulation. |
|--|

⚠ CAUTION:

- *Protect the machine from dampness or wet weather, such as rain and snow.*
- *Unplug the power cord from the wall outlet before you move the machine. While moving the machine, you should take care that the power cord will not be damaged under the machine.*
- *When you disconnect the power plug from the wall outlet, always pull the plug (not the cable).*
- *Do not allow paper clips, staples, or other small metallic objects to fall inside the machine.*
- *Keep toner (used or unused) and toner cartridge out of the reach of children.*
- *For environmental reasons, do not dispose of the machine or expended supply waste at household waste collection points. Disposal can take place at an authorized dealer.*
- *The inside of the machine could be very hot. Do not touch the parts with a label indicating the “hot surface”. Otherwise an injury might occur.*

ENERGY STAR Program

ENERGY STAR®

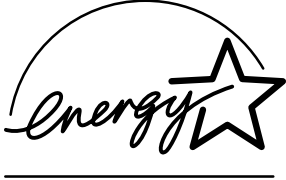

As an ENERGY STAR Partner, we have determined that this machine model meets the ENERGY STAR Guidelines for energy efficiency.

The ENERGY STAR Guidelines intend to establish an international energy-saving system for developing and introducing energy-efficient office equipment to deal with environmental issues, such as global warming.

When a product meets the ENERGY STAR Guidelines for energy efficiency, the Partner shall place the ENERGY STAR logo onto the machine model.

This product was designed to reduce the environmental impact associated with office equipment by means of energy-saving features, such as Low-power mode.

❖ Low-power Mode (Energy Saver mode)

This printer automatically lowers its power consumption 60 minutes after the last operation has been completed. To exit Low-power (Energy Saver) mode, press any key on the control panel. For details about how to configure Energy Saver mode, see *“Making Printer Settings with the Control Panel”* in Administrator Reference 2 as a PDF file on the CD-ROM.

❖ Specifications

Energy Saver mode	Power Consumption	45 W or less
	Default Time	60 minutes
	Recovery Time	120 seconds or less

How to Read This Manual

Symbols

In this manual, the following symbols are used:

 **WARNING:**

This symbol indicates a potentially hazardous situation which, if instructions are not followed, could result in death or serious injury.

 **CAUTION:**

This symbol indicates a potentially hazardous situation which, if instructions are not followed, may result in minor or moderate injury or damage to property.

* The statements above are notes for your safety.

 **Important**

If this instruction is not followed, paper might be misfed or data might be lost. Be sure to read this.

 **Preparation**

This symbol indicates the prior knowledge or preparations required before operating.

 **Note**

This symbol indicates precautions for operation, or actions to take after misoperation.

 **Limitation**

This symbol indicates numerical limits, functions that cannot be used together, or conditions in which a particular function cannot be used.

 **Reference**

This symbol indicates a reference.

[]

Keys that appear on the machine's panel display.

Keys and buttons that appear on the computer's display.

[]

Keys built into the machine's control panel.

Keys on the computer's keyboard.

TABLE OF CONTENTS

1. Replacing Consumables and Maintenance Kit

Detaching the SR770 (2 Tray Finisher).....	1
Opening and Closing the Duplex Reversal Unit.....	2
Replacing the Toner Cartridge.....	3
Replacing the Fuser Oil Unit.....	6
Replacing the Photoconductor Unit.....	10
Replacing the Development Unit.....	15
Replacing the Fusing Unit.....	19
Replacing the Dustproof Filter.....	24
Replacing the Waste Toner Bottle.....	26
Replacing the Paper Feed Rollers.....	28

2. Cleaning and Adjusting the Printer

Cautions to Take When Cleaning.....	31
Cleaning the Registration Roller.....	32
Cleaning the DustProof Glass.....	33
Adjusting the Color Registration.....	34
Auto Adjust.....	34
Fuser Adjust.....	35
Manual Adjust.....	39
Test Sheet Samples.....	41
Adjusting the Image Density.....	43
Adjusting the Registration of the Trays.....	44

3. Paper and Other Media

Paper and Other Media Supported by This Printer	47
Paper Sizes	47
Paper Recommendations	53
Loading Paper	53
Storing Paper	53
Types of Paper and Other Media	54
Printable Area	57
Loading Paper.....	58
Loading Paper in Tray 1	58
Loading Paper in Tray 2 and the Optional Paper Feed Unit	59
Loading paper in Paper Bank PS470 (2000-sheet Large Capacity Tray)	60
If you load a paper size that is not selected automatically	61
Changing the paper type.....	63
Load Paper in the Bypass Tray	64

4. Troubleshooting

Error & Status Messages on the Control Panel.....	69
Printer Does Not Print.....	81
Other Printing Problems	84
Removing Misfed Paper.....	88
Detaching the 2 Tray Finisher	88
Opening and Closing the Duplex Reversal Unit.....	89
Removing Misfed Paper in the Duplex Feed Unit	89
When "Remove Misfeed A:Internal Path" Appears	92
When "Remove Misfeed B: Fusing Unit" Appears	92
When "Remove Misfeed W: Mailbox" Appears	94
When "Remove Misfeed R: Finisher" Appears	94
When "Remove Misfeed Y: Paper Tray" Appears.....	96
When "Remove Misfeed :Duplex Unit " Appears	96
Removing Jammed Staples.....	98
Adding Staples	100
Removing Punch-hole Chips.....	102
When the message appears even after removing the Punch-hole chips ...	102

5. Appendix

When the Front Cover Does Not Close	103
Moving and Transporting the Printer	105
Moving the Printer	105
Consumables	107
INDEX.....	109

1. Replacing Consumables and Maintenance Kit

Detaching the SR770 (2 Tray Finisher)

There are times when you might have to detach the 2 Tray Finisher from the printer to remove misfed paper. This section describes how to detach the 2 Tray Finisher.

- 1** Hold the handle at the top of the 2 Tray Finisher firmly with one hand, pull the 2 Tray Finisher straight out, and let go when it stops.

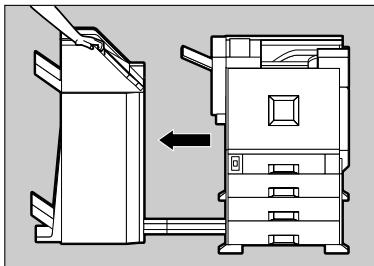

ZDJIP201J

The 2 Tray Finisher is detached from the printer.

- 2** Use both hands to push it straight back in, and let go when it clicks into place.

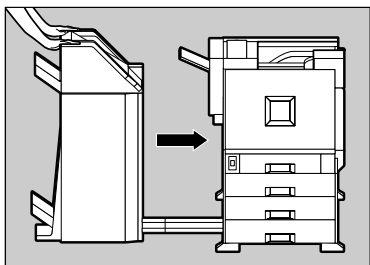

ZDJIP202J

The 2 Tray Finisher is reattached to the printer.

Important

- Be sure to attach the 2 Tray Finisher to the printer after closing the Duplex Reversal Unit. See p.2 "Opening and Closing the Duplex Reversal Unit".

Opening and Closing the Duplex Reversal Unit

1

There are times when you might have to detach the Duplex Reversal Unit to remove misfed paper. This section describes how to detach the Duplex Reversal Unit.

- 1** Push up the lock release button and keep it in place.

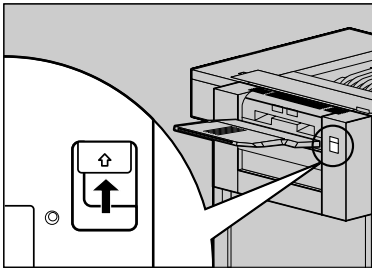

ZDJP203J

- 2** Lower the Duplex Reversal Unit slowly until it stops.

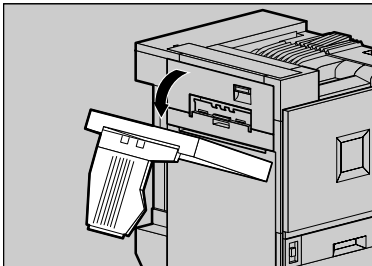

ZDJP204J

Important

- Open the Duplex Reversal Unit after detaching the 2 Tray Finisher from the printer. See p.1 "Detaching the SR770 (2 Tray Finisher)".

Note

- You do not have to remove the External Tray even if the 2 Tray Finisher is attached.

The Duplex Reversal Unit is opened.

- 3** Raise the Duplex Reversal Unit slowly with both hands, and push it in until it clicks into place.

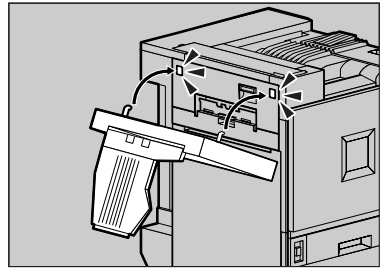

ZDJP205J

The Duplex Reversal Unit is closed.

Important

- Attach the Duplex Reversal Unit after closing the upper left cover of the printer.

Replacing the Toner Cartridge

⚠ WARNING:

- **Do not incinerate spilled toner or used toner. Toner dust is flammable and might ignite when exposed to an open flame. Disposal should take place at an authorized dealer or an appropriate collection site. If you dispose of the used toner cartridges yourself, dispose of them according to local regulations.**

⚠ CAUTION:

- **Keep toner (used or unused) and the toner cartridge out of reach of children.**

📎 Note

- ❑ The actual number of printed pages will differ depending on the paper type, size, contents and settings. For more information, see p.107 "Toner cartridge".

If "Add Toner" appears on the panel display, replace the toner cartridge.

Add Toner
XXX

or

Add Toner
XXX/XXX

📎 Note

- ❑ A combination of one to four colors, yellow, magenta, cyan, black, is displayed in "XXX".
- ❑ If cyan or magenta or yellow toner runs out, you can print in black and white mode using the black toner. Change the color mode setting to "Black and White" from the printer driver .
- ❑ If black toner runs out, printing is not possible until the black toner cartridge is replaced.

- 1 While pushing the lock button on the upper right cover of the printer (1), open the upper right cover (2).

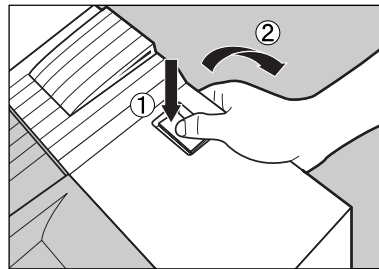

From the end, the toner cartridges are installed in the order of magenta (M), cyan (C), yellow (Y), and black (K).

1

2 Remove the toner cartridge for the color you want to replace.

1 Unhook the green hook on the toner cartridge with one hand.

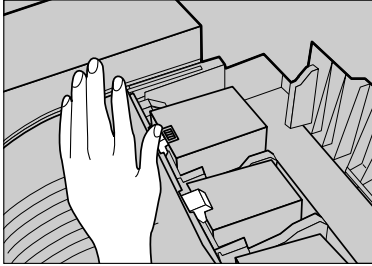

2 Holding the toner cartridge with the other hand, pull out the cartridge up slowly.

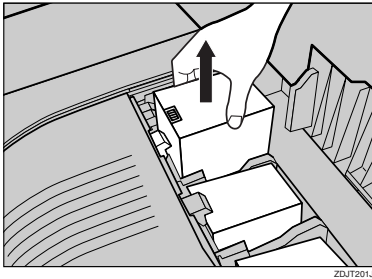

Important

Do not shake the removed toner cartridge. The remaining toner might scatter.

Note

Depending on the setting up environment, toner might be left in a toner cartridge. In such case, reinstall the toner cartridge.

3 Take out a new toner cartridge from the box.

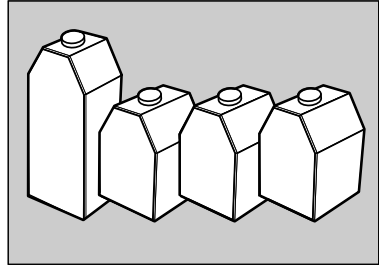

Note

The black toner cartridge contains more than the other toner cartridges.

4 Shake the toner cartridge back and forth 5-6 times.

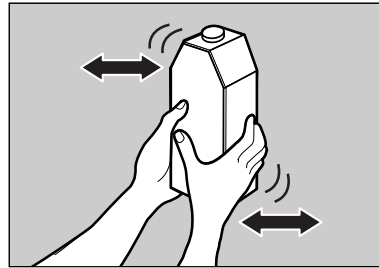

- 5** Holding the toner cartridge with the metal contact area in front, attach in the direction of the arrow.

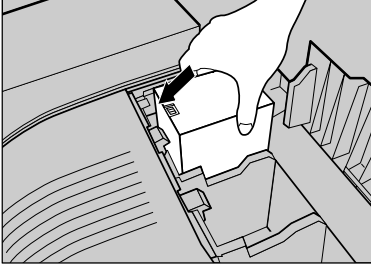

Important

- Do not touch the metal contact point with your fingers.

- 6** Insert the toner cartridge slowly until the green hook snaps on the metal contact area.

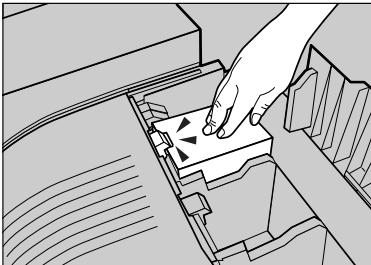

Important

- Do not install and remove the toner cartridges over and over. This could result in a toner leak.

- 7** Close the upper right cover.

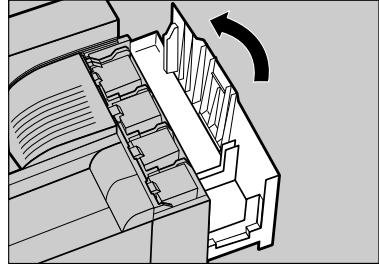

The following message appears on the panel display. Please wait a while.

Loading Toner...

Important

- Do not turn off the power switch during "Loading Toner..." appears on the panel display to avoid a printer malfunction.

Replacing the Fuser Oil Unit

1

⚠ CAUTION:

- *The Fusing Unit becomes very hot. When installing the new Fuser Oil Unit, turn off the printer and wait about an hour. After that, install the new Fusing Unit. Not waiting for the unit to cool down can result in a burn.*

If "Replace Fuser Oil Unit (TypeG)" appears on the panel display, replace the Fuser Oil Unit.

Replace Fuser
Oil Unit (TypeG)

- 1** Turn off the power switch and unplug the power cable.

⚠ Important

- Be sure to wait about an hour to prevent a burn.

- 2** If 2 Tray Finisher is installed, detach it from the printer.

🔍 Reference

See p.1 "Detaching the SR770 (2 Tray Finisher)"

- 3** If the Duplex Unit is installed, open the Duplex Reversal Unit.

🔍 Reference

See p.2 "Opening and Closing the Duplex Reversal Unit"

- 4** If the External Tray is attached to the printer, raise it in the direction of the arrow (①), and remove it (②).

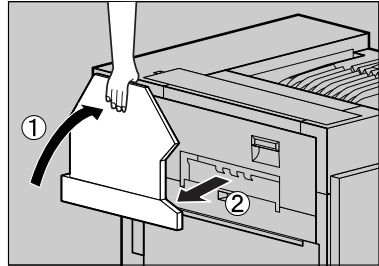

ZDJJP038J

- 5** Pull out the left cover of the printer slowly.

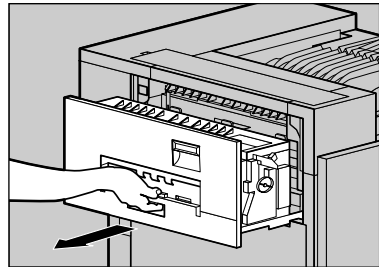

ZDJH047J

- 6** Open the upper left cover.

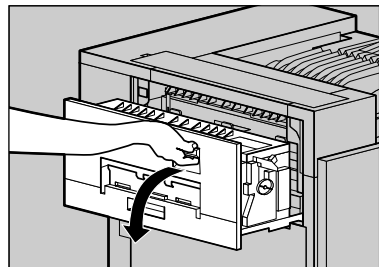

ZDJH048J

- 7** Holding the green handle, pull up the Fusing Unit slowly in the direction of the arrow.

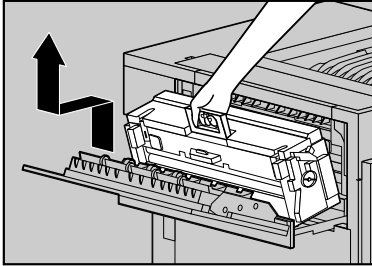

ZDJH028J

Important

- Do not touch any areas other than the handle.

- 8** Put the removed Fusing Unit in a stable and level place.

- 9** Lift the Fuser Oil Unit in the direction of the arrow to remove it, and put it in a stable and level place.

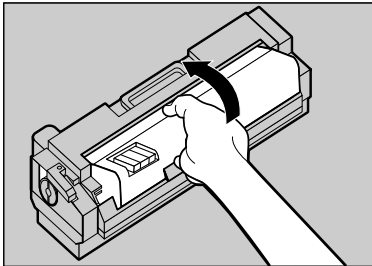

ZDJH052E

Important

- Do not touch inside of the Fusing Unit.
- Be careful no to touch the area other than the shown in the illustration.

- 10** Take out the Fuser Oil Unit from the bag, and remove seal (1), and then remove seal (2) as shown in the illustration.

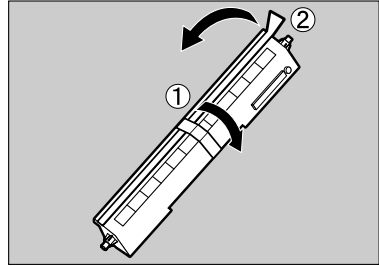

ZDJH053J

Note

- Be sure to remove seal (1), and then pull it out in a level manner.

Important

- Be sure to remove the seals to avoid printer malfunction.
- Be sure to remove seal (1) first, and then remove seal (2) to avoid oil leak.
- Be sure to put the Fuser Oil Unit in a stable and level place to avoid oil leak.
- There is oil on the removed seals and fuser oil roller. Be careful not to let them come in contact with your clothes.

- 11** Match (▲) on the front of the Fuser Oil Unit and the arrow on the Fusing Unit as shown in the illustration.

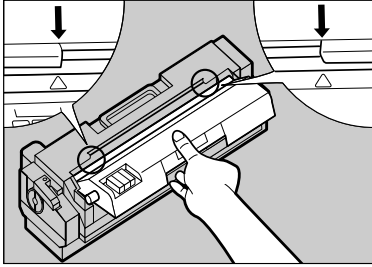

ZD.JH055.J

Important

- ❑ Be careful not to get oil on the metal point of the left side of the Fuser Oil Unit.

- 12** Insert the left and right protrusions of the Fuser Oil Unit into the white holders of the Fusing Unit (①), and then move the Fuser Oil Unit in the direction shown by the arrow (②) to attach the Fuser Oil Unit to the Fusing Unit.

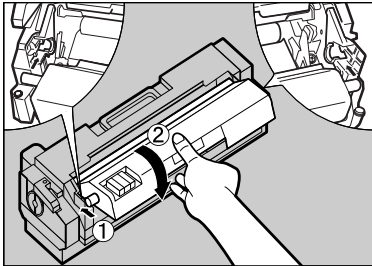

ZD.JH054.J

- 13** Holding the green handle with one hand, use your other hand to push the front area of the handle to create a slight slant, and push the Fusing Unit slowly to the back.

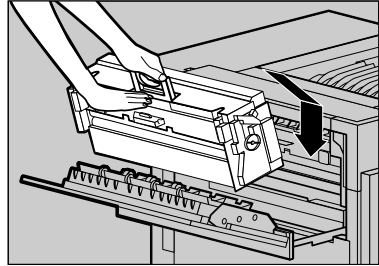

ZD.JH050E

Note

- ❑ Confirm that the Fuser Oil Unit is facing the inside of the printer.

At this point, make sure the Fusing Unit is on the stand properly.

- 14** Close the upper left cover (①) and push the handle slowly (②) to the back until it clicks into place.

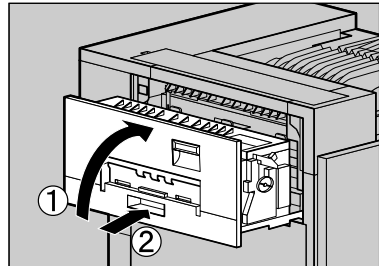

ZD.JH051.J

- 15** Place the old Fuser Oil Unit into the bag which contained the new Fuser Oil Unit, and seal the bag.

- 16** If you removed the External Tray in step 4, reattach it to the printer. Insert the hooks of the External Tray into the printer slits, and lower it toward you.

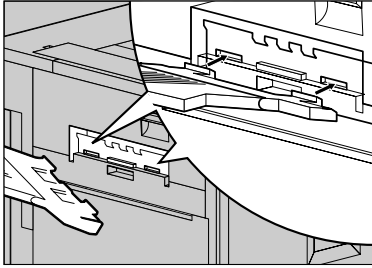

- 17** If the Duplex Unit is installed, close the Duplex Reversal Unit.

 **Reference**

See p.2 "Opening and Closing the Duplex Reversal Unit"

- 18** If the 2 Tray Finisher was installed, reattach the 2 Tray Finisher to the printer.

 **Reference**

See p.1 "Detaching the SR770 (2 Tray Finisher)"

- 19** Plug in the power cable and turn on the power switch.

 **Note**

- If you dispose of the used toner cartridges by yourself, dispose of them according to local regulations.

Replacing the Photoconductor Unit

1

If "Replace Black PCU (Type F)" appears on the panel display, replace the black Photoconductor Unit.



If "Replace Color PCU (Type A)" appears on the panel display, replace the three color Photoconductor Units.



- 1** Turn off the power switch and unplug the power cable.
- 2** Open the front cover slowly by pulling down from the two areas on the left and right.

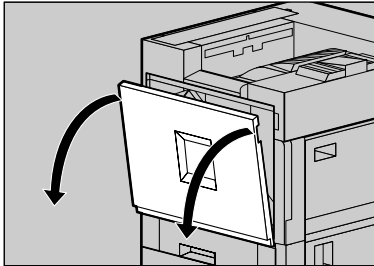

- 3** Take out the green screwdriver.

Use this screwdriver for all attachment and detachment of screws.

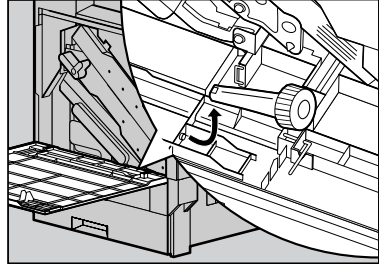

- 4** Turn the light brown lever counterclockwise.

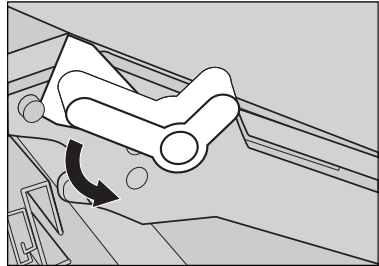

- 5** Loosen two screws that are fastening the inner cover using provided screwdriver.

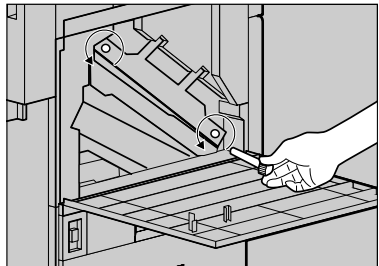

You cannot remove these two screws.

- 6** Lift the inner cover until it clicks into place and holds.

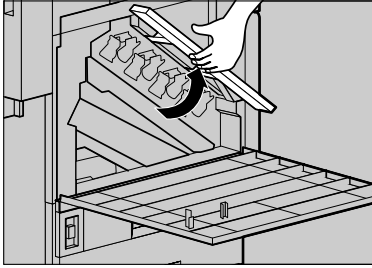

ZDJH016J

The Photoconductor Units are installed as shown in the illustration. The black Photoconductor Unit is at the upper left period. The other three are color Photoconductor Units.

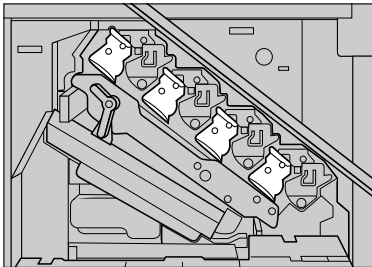

ZDJH045J

- 7** Remove the Photoconductor Unit you want to replace.

For black, remove the upper left one, and for color, remove the three on the right.

- 1** Move the green hook slowly to the right as shown in the illustration. The green hook is located on the upper right of the Photoconductor Unit.

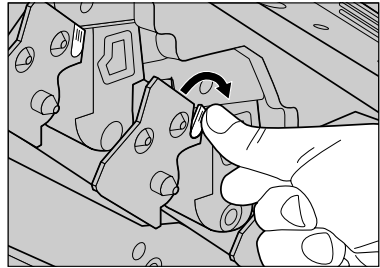

ZDJX701J

- 2** Grip the green areas at the top and bottom of the Photoconductor Unit, and pull slowly until you can see all of the green handle.

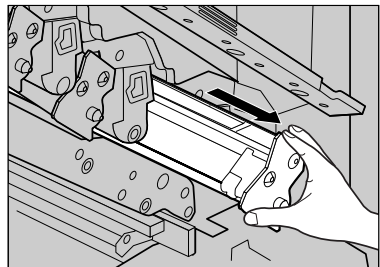

ZDJH211J

Important

- Pulling out the Photoconductor Unit quickly might cause it to drop.

1

- ③ Lift and hold the green handle at the top (①), and pull out the unit slowly (②).

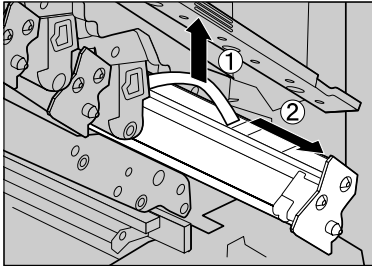

ZDJH210J

- ② Place the Photoconductor Unit, and remove the adhesive tape at the tip of the unit.

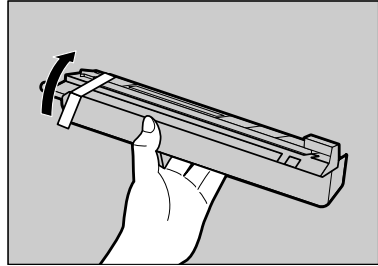

ZDJH223J

- ⑧ Install a new Photoconductor Unit.

For black, install one, and for color, install three.

- ① Take the unit out from the bag.

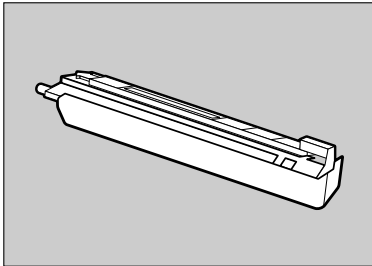

ZDJH221J

- ③ Match the green arrow at the tip of the Photoconductor Unit to the rail inside the printer.

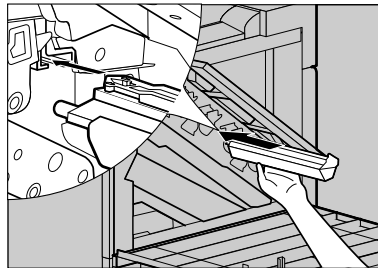

ZDJH223J

Important

- Make sure the green arrow fits securely on the rail before proceeding to the next step.

Important

- Do not remove the cover that is attached to the bottom of the Photoconductor Unit at this time.

- ④ Push the front of the Photoconductor Unit slowly, slide the unit on the cover, and push in until it stops.

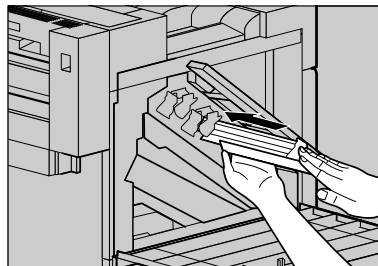

ZDJH224J

Important

- ❑ If you do not attach the green arrow of the Photoconductor Unit securely to the rail, you might damage the Photoconductor Unit.
- ❑ Do not touch the light-sensitive area of the Photoconductor Unit.

5 Remove the cover and push in the Photoconductor Unit until it stops.

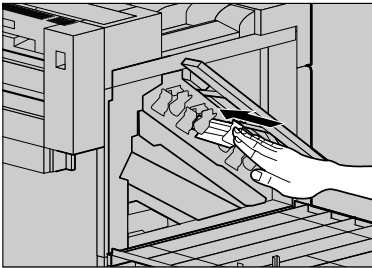

ZDJK702E

9 Lower the inner cover slowly.

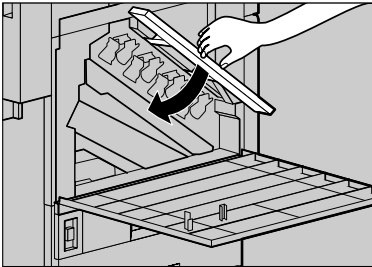

ZDJH018J

10 Tighten two screws using provided screwdriver.

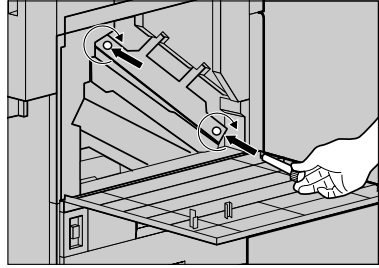

ZDJH019J

Note

- ❑ Be sure to return the provided screwdriver to its original position on the back of the front cover.

11 Turn the light brown lever clockwise.

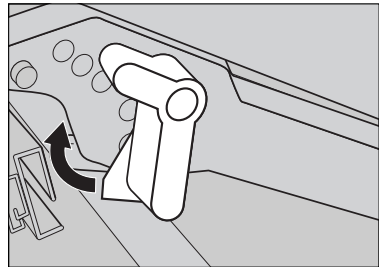

ZDJH020E

12 Close the front cover slowly by pushing the two areas on the left and right.

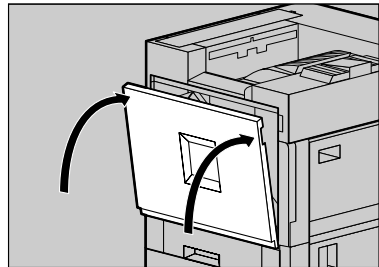

ZDJH041J

1 Plug in the power cable and turn on the power switch.

The following message appears on the panel display. The printer starts calibration. Please wait until it stops.



Calibrating...

Important

- Do not turn off the power switch during calibration to avoid a printer malfunction.

Replacing the Development Unit

If "Replace Black Dev. Unit(TypeD)" appears on the panel display, replace the black Development Unit.

Replace Black
Dev. Unit(TYPE D)

If "Replace Color Dev. Unit(TypeB)" appears on the panel display, replace the three color (CMY) Development Units.

Replace Color
Dev. Unit(TYPE B)

Note

- ❑ A dustproof filter is attached to the black Development Unit. When replacing the black Development Unit, also replace the dustproof filter. See p.24 "Replacing the Dustproof Filter".
- ❑ When replacing the black Development Unit, clean the registration roller. See p.32 "Cleaning the Registration Roller".

1 Turn off the power switch and unplug the power cable.

2 Open the front cover slowly by pulling down from the two areas on the left and right.

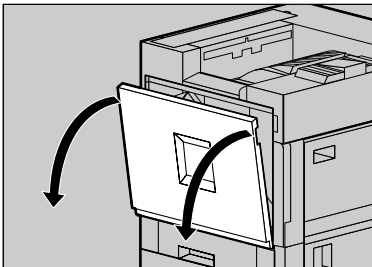

3 Take out the green screwdriver.

Use this screwdriver for all attachment and detachment of screws.

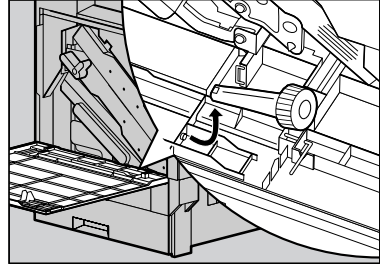

4 Turn the light brown lever counterclockwise.

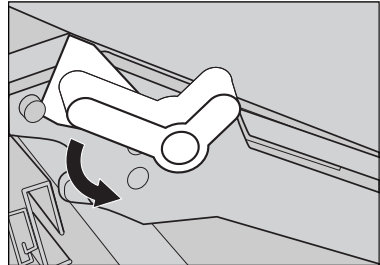

5 Loosen two screws that are fastening the inner cover using provided screwdriver.

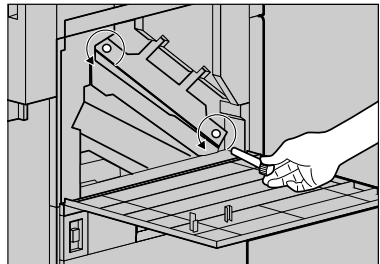

You cannot remove these two screws.

6 Lift the inner cover until it clicks into place and holds.

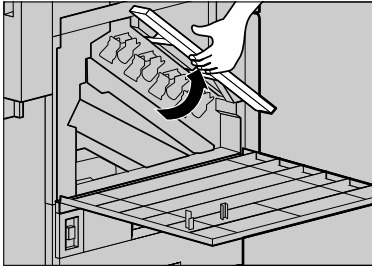

ZD.JH016J

The Development Unit is installed shown in the illustration. Starting from the upper left, the units are attached in the order of black (K), yellow (Y), cyan (C), and magenta (M).

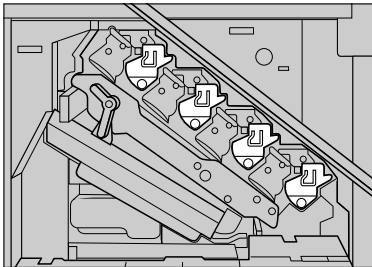

ZD.JH046J

7 Remove the Development Unit.

The procedure for removing the unit is the same for all four colors.

- 1** Hook your finger on the green tab in front of the Development Unit you want to replace, and pull it out halfway.

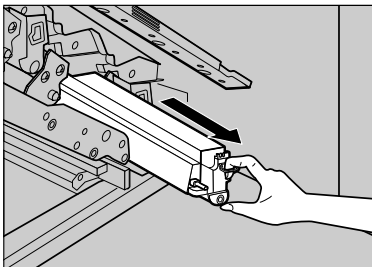

ZD.JH225J

Important

- Pulling out the Development Unit quickly might cause it to drop.
- 2** Hold the right side of the Development Unit with your right hand, and pull out the unit slowly.

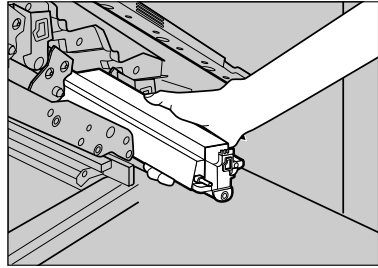

ZD.JH993J

Important

- Be careful not to touch the right side of the Photoconductor Unit.
- Be careful not to let it get in contact with your hands or clothes.

8 Install a new Development Unit.

The procedure for attaching the Development Unit is the same for all four colors.

- 1** Take the unit out from the bag.

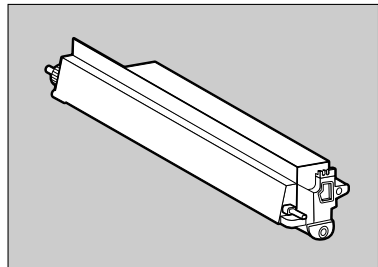

ZD.JH226J

- 2** Insert the Development Unit along the rail, and push in slowly until it stops.

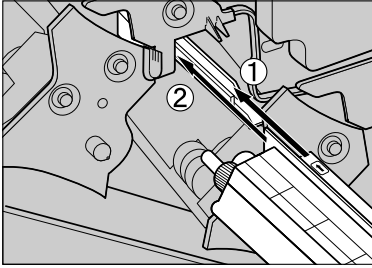

ZDJH227E

- 3** Holding the Development Unit, pull out the tape slowly in a level manner.

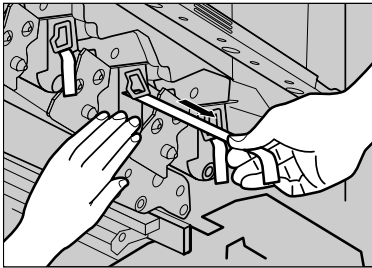

ZDJH039J

Important

- Be sure to pull out the tape to avoid printer malfunction during operation.
- The removed tape is dirty. Be careful not to let it get in contact with your hands or clothes.

- 9** Lower the inner cover slowly.

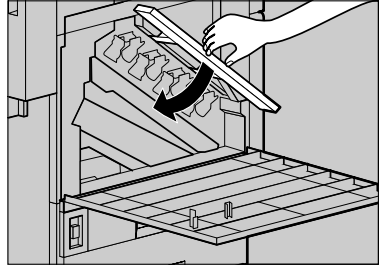

ZDJH018J

- 10** Tighten two screws using provided screwdriver.

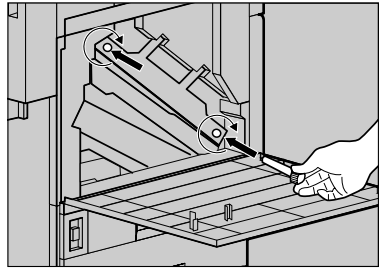

ZDJH018J

Note

- Be sure to return the provided screwdriver to its original position on the inside of the front cover.

- 11** Turn the light brown lever clockwise.

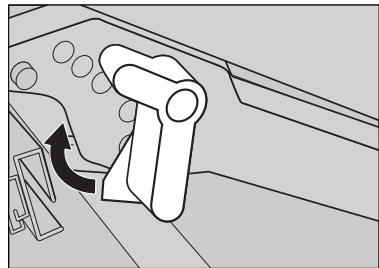

ZDJH020E

- 12** Close the front cover slowly by pushing the two areas on the left and right.

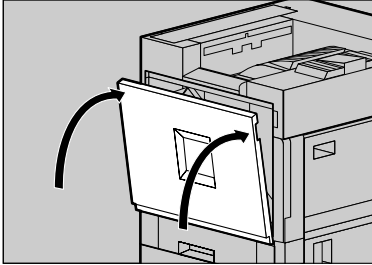

ZD/JH041.J

- 13** Plug in the power cable and turn on the power switch.

"Please Wait " appears on the panel display, and initial adjustments begin. Please wait until it stops.

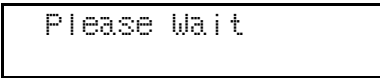

⚠ Important

- Do not turn off the power switch during adjustments to avoid a printer malfunction.

Replacing the Fusing Unit

⚠ CAUTION:

- The Fusing Unit becomes very hot. When installing the new Fusing Unit, turn off the printer and wait about an hour. After that, install the new Fusing Unit. Not waiting for the unit to cool down can result in a burn.

If "Replace Fusing Unit (Type C)" appears on the panel display, replace the Fusing Unit.

Replace Fusing
Unit (Type C)

- 1 Turn off the power switch and unplug the power cable.

⚠ Important

- Be sure to wait about an hour to prevent a burn.

- 2 If the 2 Tray Finisher is installed, detach it from the printer.

🔍 Reference

See p.1 "Detaching the SR770 (2 Tray Finisher)"

- 3 If the Duplex Unit is installed, open the Duplex Reversal Unit.

🔍 Reference

See p.2 "Opening and Closing the Duplex Reversal Unit"

- 4 If the External Tray is attached to the printer, raise it in the direction of the arrow (①), and remove it (②).

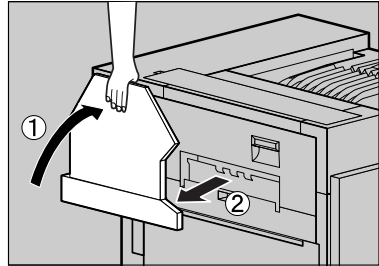

- 5 Pull out the left cover of the printer.

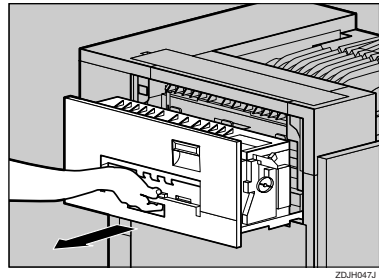

- 6 Open the upper left cover.

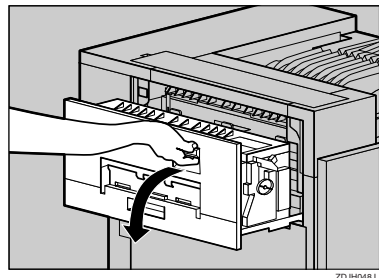

⚠ Important

- Do not touch any areas other than the handle.

1

- 7** Holding the green handle, pull up the Fusing Unit slowly in the direction of the arrow, and then put it in a stable and level place.

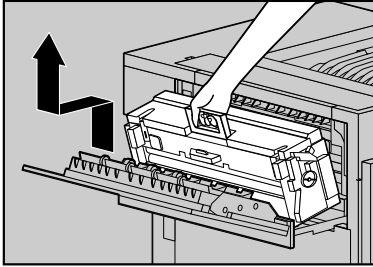

ZDJH028J

- 8** Take out the new Fusing Unit from the bag and put it in a stable and level place.

Important

- The A3 paper which comes with the new Fusing Unit will be used in a later step 20, so be careful not to lose it.
- Do not turn the blue dial at the side of the new fusing unit when replacing it or before turning on the power switch.

- 9** Remove the Fuser Oil Unit in the direction of the arrow.

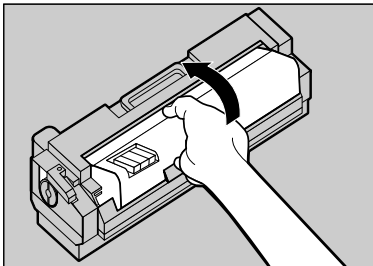

ZDJH052E

Important

- Do not touch inside of the Fusing Unit.
- Be careful not to touch the oil.

- 10** Match (▲) on the front of the Fuser Oil Unit and the arrow on the Fusing Unit as shown in the illustration.

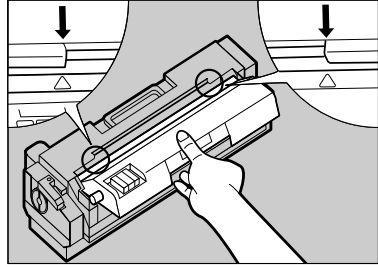

ZDJH055J

Important

- Be careful not to get oil on the metal point of the left side of the Fuser Oil Unit.

- 11** Insert the left and right protrusions of the Fuser Oil Unit into the white holders of the Fusing Unit (①), and then move the Fuser Oil Unit in the direction shown by the arrow (②) to attach the Fuser Oil Unit to the Fusing Unit.

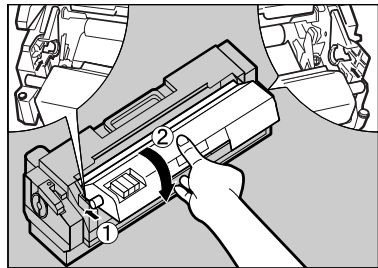

ZDJH054J

- 12** Put the removed Fuser Oil Unit in the bag that enclosed the new Fusing Unit, and then seal it.

- 13** Holding the green handle of the new Fusing Unit, use your other hand to push the area right in front of the handle to create a slight slant, and then push the Fusing Unit slowly to the back.

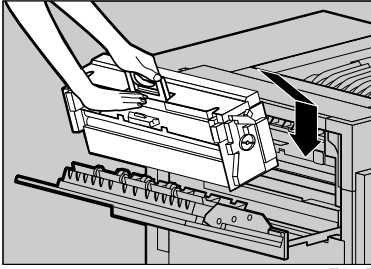

ZDJH050E

Important

- Confirm that the Fuser Oil Unit is facing the inside of the printer.
- Confirm that the Fusing Unit is properly positioned in the machine.

- 14** Close the upper left cover (1) and push the handle (2) slowly to the back until it clicks into place.

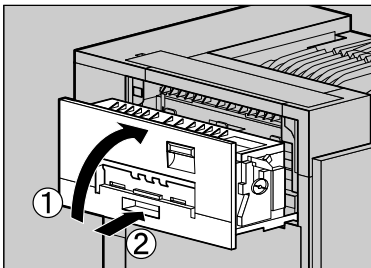

ZDJH051J

- 15** If you removed the External Tray in step 4, reattach it to the printer. Insert the hooks of the External Tray into the printer slits, and lower it toward you.

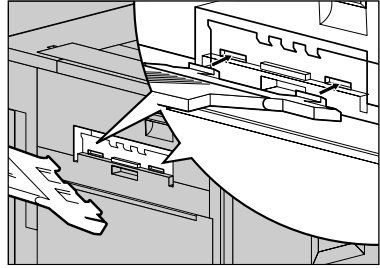

ZDJH010J

- 16** If the Duplex Unit is installed, close the Duplex Reversal Unit.

Reference

See p.2 "Opening and Closing the Duplex Reversal Unit"

- 17** If the 2 Tray Finisher was installed, reattach the 2 Tray Finisher to the printer.

Reference

See p.1 "Detaching the SR770 (2 Tray Finisher)"

- 18** Plug in the power cable and turn on the power switch.

The following message appears on the panel display. Please wait for a while.

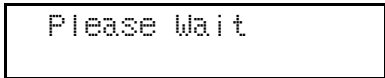

1

The following message appears on the panel display, and the printer starts color registration adjustment automatically. Please wait for a while.

Calibrating...

After finishing adjustment, the following message appears.

Initializing...
Please Wait

- 19 Confirm that the following message is displayed on the panel display, and then press **[Enter]**.

Press # for
Fuser Adjust

- 20 Confirm that the following message is displayed on the panel display, and then load the A3 paper which comes with the Fusing Unit in the Bypass Tray.

Set Sheet in
Bypass, then #

- 1 Open the Bypass Tray.

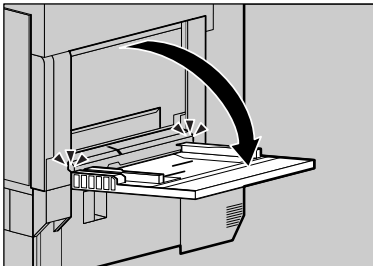

- 2 Pull out the Bypass Tray Extension, and then flip it open.

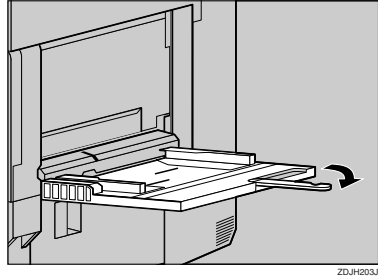

- 3 Slide the side guides outward (1), and then load paper until it stops (2).

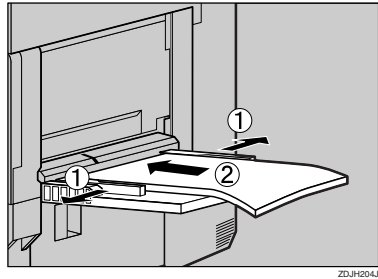

- 4 Adjust the side guides to the paper width.

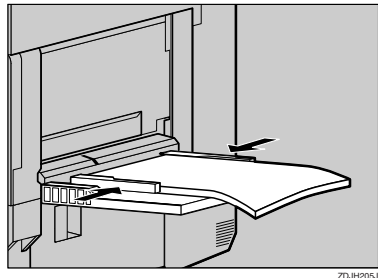

Important

- Be sure to shuffle the paper before loading the stack onto the tray so multiple sheets are not fed in at one time.

- 21** Confirm that the A3 paper which comes with the Fusing Unit is in the Bypass Tray, and then press **[Enter]**.

The printer prints 8 Test Sheet (A - H). For details about Test Sheet, see p.41 "Test Sheet Samples".



Note

- It takes about a minute to start printing.

- 22** Check the test sheets and select the correction value for A through H.

- Select "1", if black and magenta square overlap sharply and you can see white slits as the sample.
- Select "0", if black and magenta square do not overlap sharply and you can not see white slits clearly.

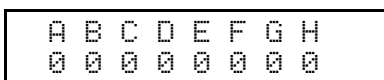

Press **[▲]** or **[▼]** to select "0" or "1" as the values for A - H. Press **[Enter]** to move to the next letter. After setting the value for "H", press **[Enter]**, and the printer returns to the ready condition.



Important

- If you select "0" for each alphabets or an invalid value is selected, an error message is displayed. In this case, press **[Enter]** to return to the ready condition, and perform the "Fuser Adjust" manually. See p.35 "When replacing the fusing unit".

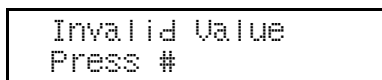

- When "Toner is Almost Empty" appears on the panel display, replace the toner cartridge and perform the "Auto Adjust", and then perform "Fuser Adjust" manually.

Reference

- ⇒ p.3 "Replacing the Toner Cartridge"
- ⇒ p.34 "Auto Adjust"
- ⇒ p.35 "When replacing the fusing unit" for "Fuser Adjust"

Replacing the Dustproof Filter

1

The dustproof filter is attached to the black Development Unit. When replacing the black Development Unit, also replace the dustproof filter.

The dustproof filter is attached to the left side of the printer shown in the illustration.

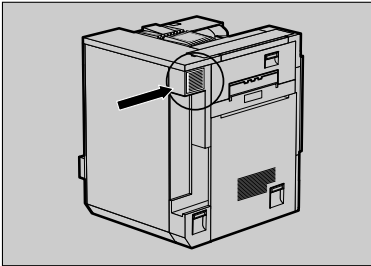

1 Turn off the power switch and unplug the power cable.

2 Push in the grips on both sides of the dustproof filter cover to pull it off.

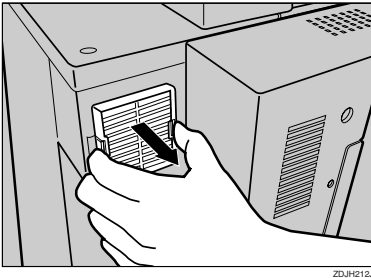

Note

- ❑ Be sure to put the removed dustproof filter cover in a stable and level place.

3 From the box which contained the black Development Unit, take out the new dustproof filter and glove.

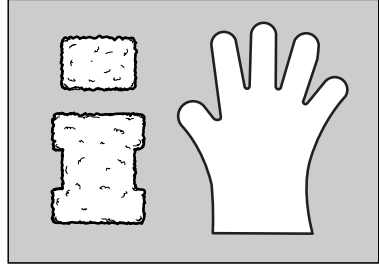

4 Wear the glove on either hand.

- 5** With the hand wearing the glove, take out the dustproof filter that is attached to the dustproof filter cover slowly, one by one, and put them into the box which contained the black Development Unit.

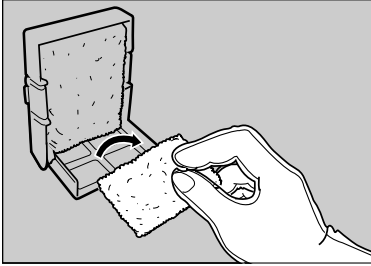

ZDJH215J

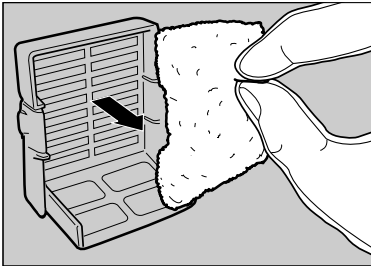

ZDJH215J

Important

- Handle the removed dustproof filters with care. If you shake them, the attached dust might scatter.
- Be sure to remove the gloves to attach the new dustproof filter.

- 6** Attach the new dustproof filters to the dustproof filter cover one by one.

- 1** Attach the large filter.

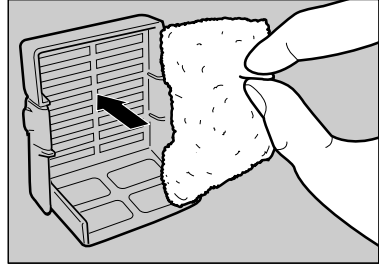

ZDJH216J

- 2** Attach the small filter.

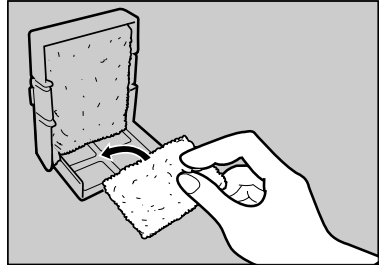

ZDJH217J

- 7** Insert the dustproof filter cover into the upper left area of the printer.

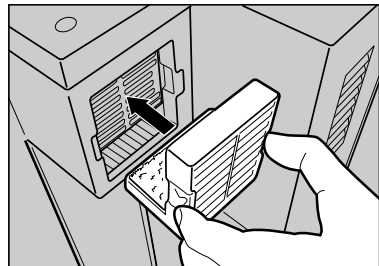

ZDJH218J

- 8** Plug in the power cable and turn on the power switch.

Replacing the Waste Toner Bottle

1

If "Replace Waste Toner (Type E)" appears on the panel display, replace the waste toner bottle.



- 1** Turn off the power switch and unplug the power cable.
- 2** Open the front cover slowly by pulling down from the two areas on the left and right.

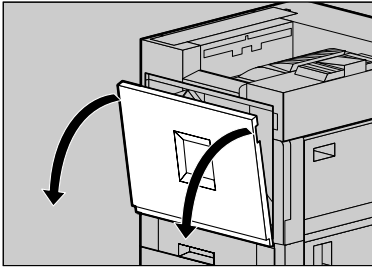

ZD.JH07J

- 3** Take out a new waste toner bottle from the bag.

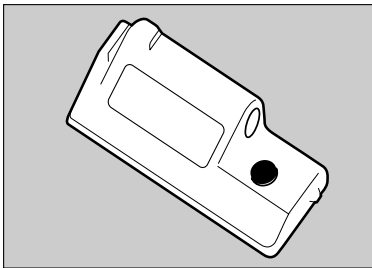

ZD.JH28J

- 4** Remove the used waste toner bottle slowly from inside the printer.

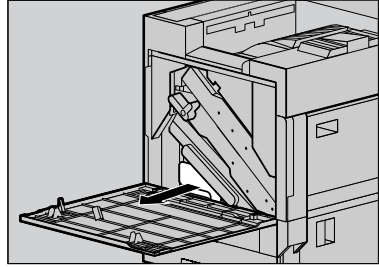

ZD.JH62J

Important

- Be sure to remove the waste toner bottle in a level manner.

- 5** Remove the lid (①), and then put it on the position shown in the illustration (②).

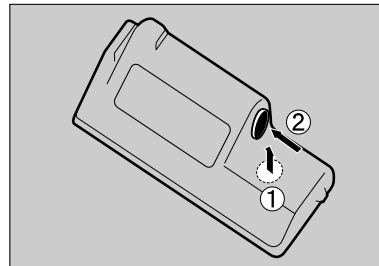

ZD.JH29J

- 6** Put the used waste toner bottle into the bag that contained the new waste toner bottle, and then seal the bag.

Important

- Be sure to handle the bottle carefully so the waste toner does not spill.

- 7** Insert the new waste toner bottle in the position shown in the illustration.

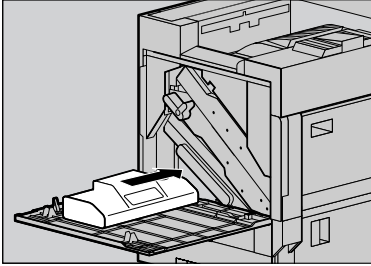

- 8** Push it in until it stops.

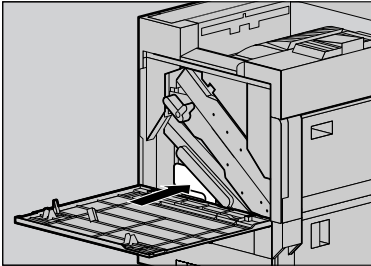

Important

- Be sure to insert the waste toner bottle firmly to avoid the toner from leaking inside the printer.

- 9** Close the front cover slowly by pushing the two areas on the left and right.

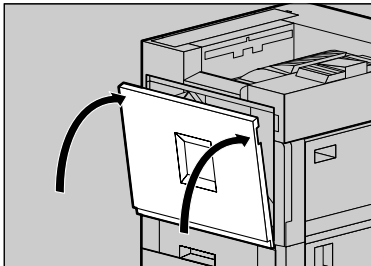

Replacing the Paper Feed Rollers

1

Note

- The following illustrations are the examples of replacing the paper feed rollers of Tray 1. The same procedure is followed with the other trays.

1 Check the contents of the box.

◆ Paper Feed Roller A



◆ Paper Feed Roller B



◆ Paper Feed Roller C



◆ Two Stoppers



2 Turn off the power switch and unplug the power cable and interface cable.

Important

- If you replace the paper feed rollers of the optional 2000-sheet Large Capacity Tray, remove all paper from the tray.

3 Pull out all trays slowly while lifting it up a little.

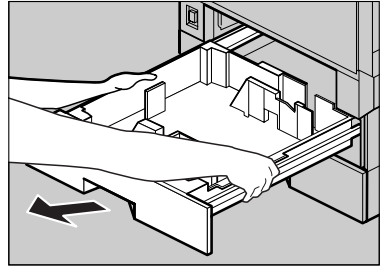

ZERH010E

Note

- If you replace the paper feed rollers of the optional Paper Feed Unit, or 2000-sheet Large Capacity Tray, pull out all the paper trays from each unit.

4 Confirm the position of the paper feed rollers.

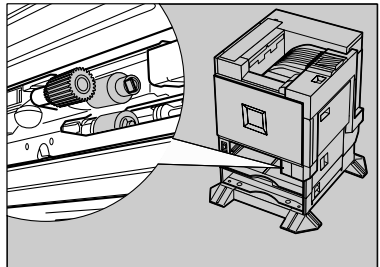

ZERH020E

Confirm the positions and names of each roller.

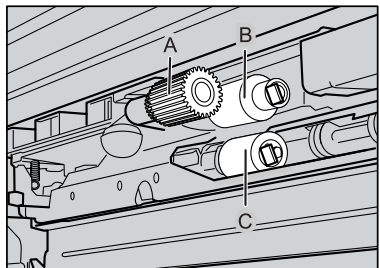

ZERH030E

- 5** While pushing the pin of the paper feed roller A outwards (①), remove the paper feed roller (②).

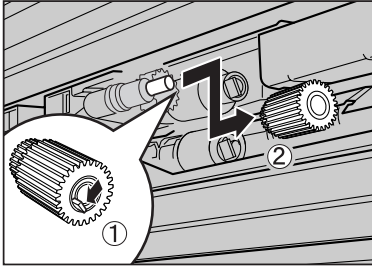

ZERH040E

- 6** Remove the stopper from the paper feed roller B (①), and remove the paper feed roller (②).

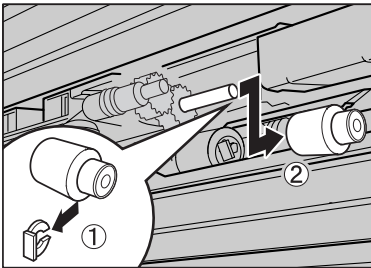

ZERH050E

- 7** Remove the stopper from the paper feed roller C (①), and remove the paper feed roller (②).

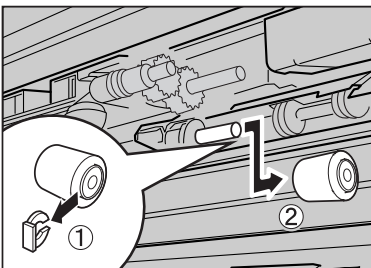

ZERH060E

- 8** Hold the new paper feed roller C with its gear towards the shaft. Insert it into the rear shaft so that the roller gear is meshed with the shaft gear (①). Lock the roller with the stopper (②).

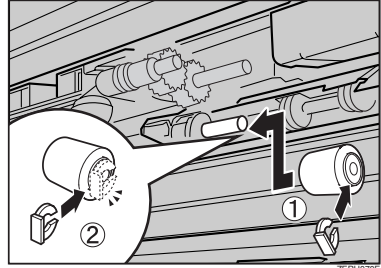

ZERH070E

- 9** Hold the new paper feed roller B with its gear towards the shaft. Insert it into the rear shaft so that the roller gear is meshed with the shaft gear (①). Lock the roller with the stopper (②).

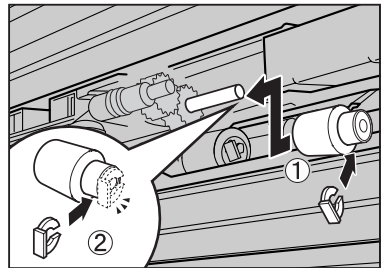

ZERH080E

1

- 10** Hold the new paper feed roller A with its pin towards you (①). Insert the roller onto the front shaft until it clicks into place (②).

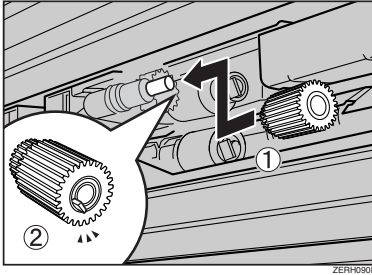

- 11** Slide all trays back into the printer slowly until it stops.

Note

- If you replaced the paper feed rollers of the optional 2000-sheet Large Capacity Tray, load stocks that you removed at step **2** in the tray.

2. Cleaning and Adjusting the Printer

Cautions to Take When Cleaning

 **WARNING:**



- ***Do not remove any covers or screws other than those specified in this manual. Some parts of the machine are at a high voltage and could give you an electric shock. Also, if the machine has laser systems, direct (or indirect) reflected eye contact with the laser beam may cause serious eye damage. When the machine needs to be checked, adjusted, or repaired, contact your service representative.***
- ***Do not take apart or attempt any modifications to this machine. There is a risk of fire, electric shock, explosion or loss of sight. If the machine has laser systems, there is a risk of serious eye damage.***

 **CAUTION:**



- ***When removing misfed paper, do not touch the fusing section because it could be very hot.***

Clean the printer periodically to maintain fine printing.

Dry wipe the exterior with a soft cloth. If dry wiping is not enough, wipe with a soft, wet cloth that is wrung out well. If you still cannot remove the stain or grime, use a neutral detergent, then wipe over with a well-wrung wet cloth, dry wipe, and let it dry.

 **Important**

- To avoid deformation, discoloration, or cracking, do not use volatile chemicals, such as benzine and thinner, or spray insecticide on the printer.
- If there is dust or grime inside the printer, wipe with a clean, dry cloth.

Cleaning the Registration Roller

⚠ CAUTION:

- *The inside of the printer becomes very hot. Do not touch the parts with a label indicating the "hot surface", otherwise it could cause a burn.*

Clean the roller when replacing the black Development Unit.

1 Turn off the power switch and unplug the power cable.

2 Open the right cover shown in the illustration.

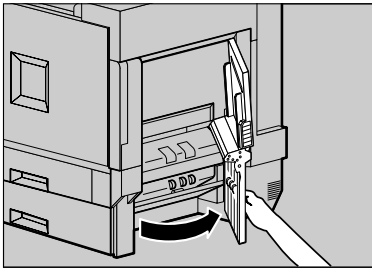

The registration roller is set shown in the illustration.

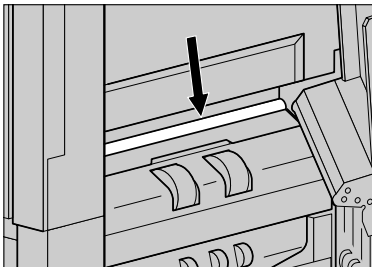

3 Wipe around the registration roller by turning with a soft damp cloth.

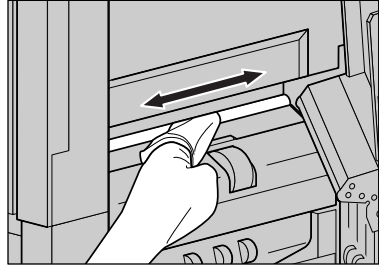

⚠ Important

- Do not use chemical cleaner or organic solvent such as thinner or benzene.

4 Close the right cover by pushing the area labeled "PUSH".

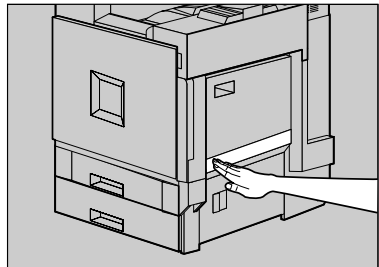

5 Plug in the power cable and turn on the power switch.

Cleaning the DustProof Glass

The dustproof glass may require cleaning if white lines appear on the print side of the document.

- 1** Turn off the power switch and unplug the power cable.
- 2** Open the front cover and remove the cleaning brush.

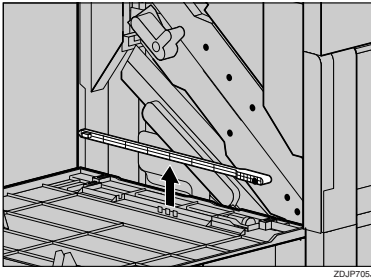

There are four holes for cleaning the dustproof glass.

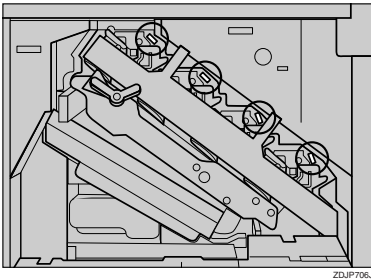

- 3** Slide the cleaning brush in and out slowly 8 to 10 times to clean all four areas.

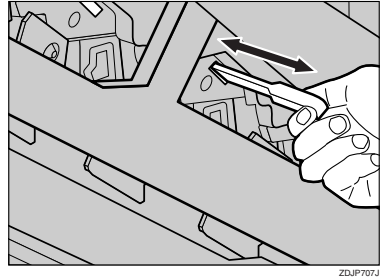

Important

- Do not insert the brush roughly, or the printer might be damaged.
- 4** Return the cleaning brush to its original position.
 - 5** Plug in the power cable and turn on the power switch.

Adjusting the Color Registration

2

When the printer is moved, when the Fusing Unit is replaced, or after printing repeatedly for some time, registration shifting might occur. By performing color registration adjustment, you can maintain optimum print results.

Note

- Normally, do not perform manual color adjustment.

Auto Adjust

If the color documents show registration shifting, perform automatic color adjustment.

1 Press **[Menu]**.

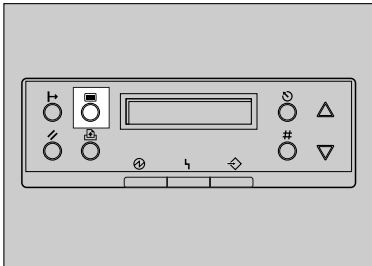

ZD45001J

"Menu" appears on the panel display.

2 Press **[▲]** or **[▼]** to display "Maintenance", and then press **[Enter]**.

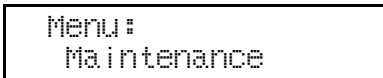

The maintenance menu is displayed.

3 Press **[▲]** or **[▼]** to display "Color Regist.", and then press **[Enter]**.



4 Confirm that "Auto Adjust" is displayed, and then press **[Enter]**.



5 Confirm that "Now" is displayed, and then press **[Enter]**.

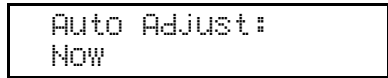

The check message is displayed.



6 Press **[Enter]**.

Automatic color adjustment begins, and the following message is displayed.

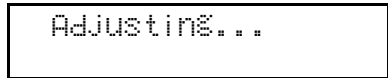

Important

- Do not turn off the power switch during "Adjusting..." appears on the panel display to avoid printer malfunction.

Automatic color adjustment takes about two minutes. When it completes, a check message is displayed.

Completed

Press **[Enter]** to return to the color adjustment menu.

Color Resist. :
Auto Adjust

- 7** When you have made all the settings, press **[On Line]**.

"Ready" appears on the panel display.

Ready

Fuser Adjust

When replacing the fusing unit

Note

- When "Toner is Almost Empty" appears on the panel display, replace the toner cartridge and perform "Auto Adjust", and then perform the "Fuser Adjust".

Reference

⇒ p.3 "Replacing the Toner Cartridge"

⇒ p.34 "Auto Adjust"

- 1** Press **[Menu]**.

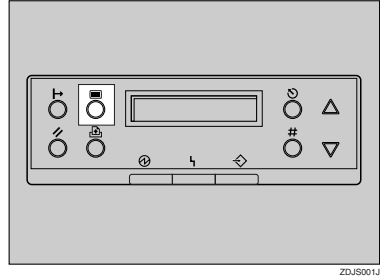

"Menu" appears on the panel display.

- 2** Press **[▲]** or **[▼]** to display "Maintenance", and then press **[Enter]**.

Menu:
Maintenance

The maintenance menu is displayed.

- 3** Press **[▲]** or **[▼]** to display "Color Resist.", and then press **[Enter]**.

Maintenance:
Color Resist.

- 4** Press **[▲]** or **[▼]** to display "Fuser Adjust", and then press **[Enter]**.

Color Resist. :
Fuser Adjust

Important

- ❑ When the toner cartridge is almost empty or "Auto Adjust" is not finished, the following message appears on the panel display and Fuser Adjust is not available.

```
Cannot Adjust
See User's Guide
```

Confirm that the toner cartridge is installed. The toner cartridge must be installed. See p.3 "Replacing the Toner Cartridge".

If the toner cartridge is installed, perform "Auto Adjust". See p.34 "Auto Adjust".

- 5 Press **[▲]** or **[▼]** to display "At Unit Replace", and then press **[Enter]**.

```
Fuser Adjust:
At Unit Replace
```

- 6 Confirm that "Print" is displayed on the menu for printing the test sheet, and then press **[Enter]**.

```
Test Sheet:
Print
```

The following message appears on the panel display.

```
Set Sheet in
Bypass, then #
```

- 7 Confirm that the A3 paper which comes with the Fusing Unit is in the Bypass Tray, and then press **[Enter]**.

The printer prints 8 Test Sheet (A - H). For details about Test Sheet, see p.41 "Test Sheet Samples"

- 8 Check the test sheets and select the correction value for A through H.

- Select "1", if black and magenta square overlap sharply and you can see white slits as the sample.
- Select "0", if black and magenta square do not overlap sharply and you can not see white slits clearly.

```
A B C D E F G H
0 0 0 0 0 0 0 0
```

Press **[▲]** or **[▼]** to select "0" or "1" as the values for A - H. Press **[Enter]** to move to the next letter. After setting the value for "H", press **[Enter]** and the printer returns to "At Unit Replace".

Note

- ❑ If you select "0" for each alphabets or an invalid value is selected, an error message is displayed and the printer returns to "At Unit Replace". In this case, try again from step 5.

```
Invalid Value
Cannot Adjust
```

- 9 Press **[On Line]**.

"Ready " appears on the panel display.

```
Ready
```

When color shifting occurs

Perform this procedure when color shifting occurs even after performing "Auto Adjust".

- 1 Load A4 or larger paper in the Bypass Tray.

Note

- Be sure to select paper size in the "Paper Input" menu.

Reference

For details about paper size and the procedure for loading paper in the Bypass Tray, see p.64 "Load Paper in the Bypass Tray".

- 2 Press **[Menu]**.

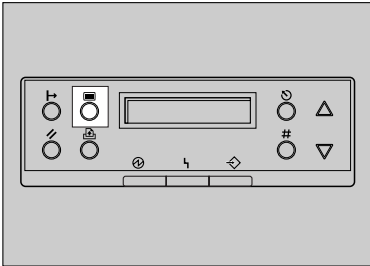

ZDJ5001J

"Menu" appears on the panel display.

- 3 Press **[▲]** or **[▼]** to display "Maintenance", and then press **[Enter]**.

```
Menu:
Maintenance
```

The maintenance menu is displayed.

- 4 Press **[▲]** or **[▼]** to display "Color Regist.", and then press **[Enter]**.

```
Maintenance:
Color Regist.
```

- 5 Press **[▲]** or **[▼]** to display "Fuser Adjust", and then press **[Enter]**.

```
Color Regist.:
Fuser Adjust
```

Important

- When the toner cartridge is almost empty, or Auto Adjust is not finished, the following message appears on the panel display and "Fuser Adjust" is not available.

```
Cannot Adjust
See User's Guide
```

Confirm that the toner cartridge is installed. The toner cartridge must be installed. See p.3 "Replacing the Toner Cartridge".

If the toner cartridge is installed, perform "Auto Adjust".

- 6 Press **[▲]** or **[▼]** to display "Custom Adjust", and then press **[Enter]**.

The following message appears on the panel display.

```
Fuser Adjust:
Custom Adjust
```

7 Press **[▲]** or **[▼]** to display the paper types and resolution in which color shifting occurs, and then press **[Enter]**.

```
Custom Adjust:
Plain: 600dpi
```

Select a value from "Plain: 600dpi", "Plain: 1200dpi" and "Thick: 600dpi".

Note

- The current resolution is displayed on the printer driver properties.
- To adjust the color registration on thick paper, select "Thick: 600dpi" regardless of the current resolution.

8 Confirm that the following message is displayed, and then press **[Enter]**.

```
Press # for Test
Print (Bypass)
```

The following message appears on the panel display. The size of the paper loaded in step **1** is shown.

```
Set Sheet, then#
A3 (297 X 420)
```

9 Confirm that A4 or larger paper is in the Bypass Tray, and then press **[Enter]**.

The Test Sheet is printed. See p.41 "Test Sheet Samples"

10 Press **[▲]** or **[▼]** to make the offset settings, and then press **[Enter]**.

When such a clear (not smeared in red) square as the sample is:

- at its center position, select "0".
- shifted to the left, select "-1".
- shifted to the right, select "+1".

```
Select Action:
0: Exit
```

```
Select Action:
-1: Re-adjust
```

```
Select Action:
+1: Re-adjust
```

If you select "0: Exit", the printer returns to the previous menu.

If you select "-1" or "+1", the printer returns to step **8**. Keep adjusting until "0" is available.

11 Press **[On Line]**.

"Ready " appears on the panel display.

```
Ready
```

Manual Adjust

Important

- Normally, do not perform manual color adjustment.

1 Press **[Menu]**.

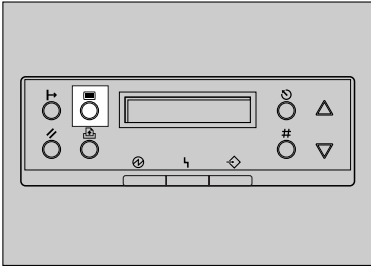

"Menu" appears on the panel display.

2 Press **[▲]** or **[▼]** to display "Maintenance", and then press **[Enter]**.

```
Menu:
Maintenance
```

The maintenance menu is displayed.

3 Press **[▲]** or **[▼]** to display "Color Regist.", and then press **[Enter]**.

```
Maintenance:
Color Regist.
```

4 Press **[▲]** or **[▼]** to display "Manual Adjust", and then press **[Enter]**.

```
Color Regist.:
Manual Adjust
```

5 Confirm that "Print" is displayed in the menu for printing the Test Sheet, and then press **[Enter]**.

```
Test Sheet:
Print
```

The Test Sheet is printed. See p.41 "Test Sheet Samples".

6 Enter the corrective values for A through L on the Test Sheet in order.

```
Adjustment A:
(-7.0 +7.0) +0
```

Note

- Confirm the printed Test Sheet to enter the correction values.

1 Use **[▲]** or **[▼]** to enter the value (-7.0 to +7.0) shown next to the whitest square, into box A of the Test Sheet.

```
Adjustment A:
(-7.0 +7.0) +2
```

Note

- Pressing **[▲]** or **[▼]** increases or decreases the value in 0.5 units.
- Sometimes, there are two of the whitest squares next to each other. For example, if the two squares of "+1" and "+2" are the whitest, enter "+1.5".
- You can adjust the color alignment for each color in the range of "-7.0 to +7.0".
- There is an area on the Test Sheet for you to put down the values of "A" through "L".

2

- ② Press **[Enter]**.
- ③ Make the settings for "B" to "L" in the same manner, using steps ① and ②.
- ④ When you finish the settings up to "L", press **[Enter]** in the next menu.

```
Manual Adjust:  
Print Result
```

The Test Sheet is printed. See p.41 "Test Sheet Samples".

```
Printing...
```

- ⑤ Confirm that square "0" is the whitest within A through L on the printed Test Sheet.

 **Note**

- If a square other than "0" is the whitest, redo the procedure from step ④.

The display is returned to the manual adjustment menu.

```
Color Resist. :  
Manual Adjust
```

- ⑦ When you have made all the settings, press **[On Line]**.

"Ready " appears on the panel display.

```
Ready
```

Test Sheet Samples

Following images are samples for the test sheet.

❖ ColorRegistSheet

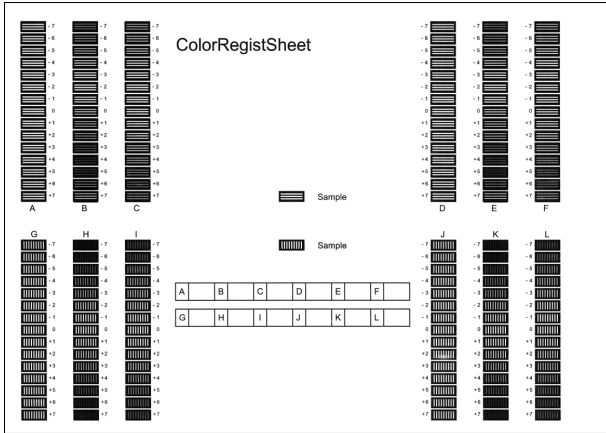

2

❖ Fuser Adjust Sheet I

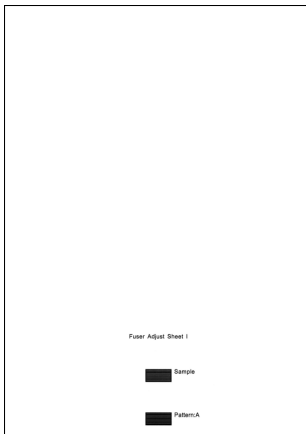

◆ Fuser Adjust Sheet II

2

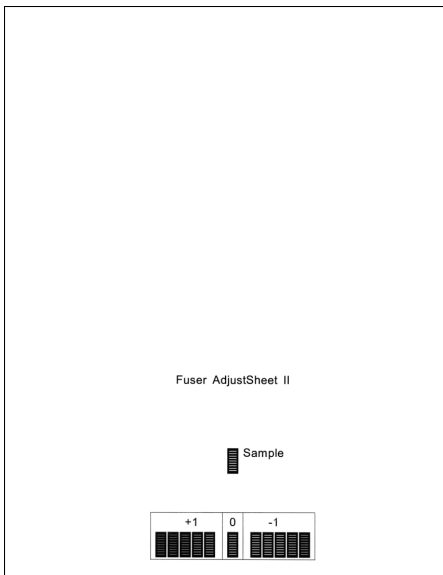

Adjusting the Image Density

Adjust the image density when the print side of the page is a hazy gray or the print image looks patchy.

Important

- Extreme settings may create output that appears dirty.
- Image density settings should be made from the application or the printer driver whenever possible.

Note

- Changing the image density setting might cause a deterioration of color balance. We recommend that you leave the image density at its factory default setting.

1 Press **[Menu]**.

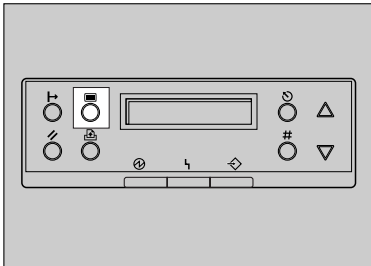

"Menu" appears on the panel display.

2 Press **[▲]** or **[▼]** to display "Maintenance", and then press **[Enter]**.

```
Menu:
Maintenance
```

3 Press **[▲]** or **[▼]** to display "Image Density", and then press **[Enter]**.

```
Maintenance:
Image Density
```

4 Press **[▲]** or **[▼]** to select the color you want to adjust, and then press **[Enter]**.

```
Image Density:
Black
```

5 Press **[▲]** or **[▼]** to set the image density value, and then press **[Enter]**.

```
Black:
(-3 +3)      0
```

Note

- You can adjust the image density in seven steps from -3 to +3. Increasing the value makes the printouts darker and decreasing the value makes the printouts lighter.

To adjust another color, repeat step **4** and **5**.

6 Press **[On Line]**.

"Ready" appears on the panel display.

```
Ready
```

Adjusting the Registration of the Trays

You can adjust the registration of each tray. The vertical adjustment is used for all trays. Normally, you need not update the registration. But when the optional Paper Feed Unit or the Duplex Unit is installed, updating the registration is useful in some cases. The following procedure describes how to adjust Tray 3. You can use the same procedure to adjust the other tray as well.

- 1 Press **[Menu]**.

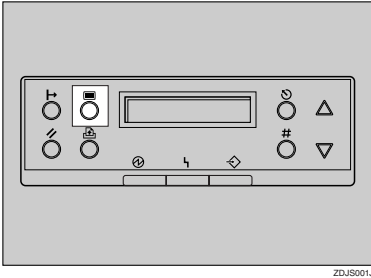

"Menu" appears on the panel display.

- 2 Press **[▲]** or **[▼]** to display "Maintenance", and then press **[Enter]**.

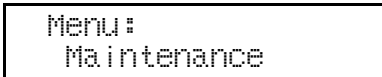

- 3 Press **[▲]** or **[▼]** to display "Registration", and then press **[Enter]**.

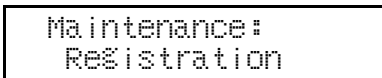

- 4 Print the test sheet to preview the settings.

- 1 Confirm that "Test Sheet" is displayed, and then press **[Enter]**.



- 2 Press **[▲]** or **[▼]** to display the tray to adjust, then press **[Enter]**.

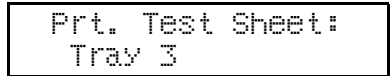

- 5 Confirm the position of the image to test sheet, and then adjust the registration value.

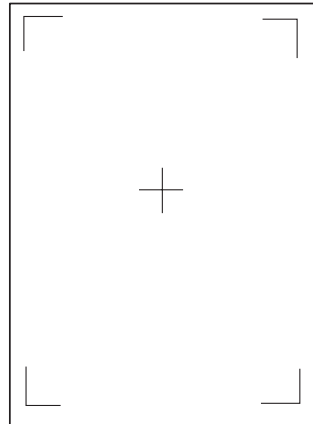

The following are examples for adjusting the margin on the test sheet.

- 1 Press **[Escape]**.

- ② Press **[▲]** or **[▼]** to display the "Adjustment", and then press **[Enter]**.

```
Registration:
Adjustment
```

- ③ Press **[▲]** or **[▼]** to display the tray to adjust, and then press **[Enter]**.

```
Adjustment:
Vert.: Tray 3
```

- ④ Press **[▲]** or **[▼]** to set the digit of the registration value (mm).

```
Vert.: Tray 3:
(-5.0 +5.0) 0
```

 **Note**

- Increase the value to shift the print area in a positive direction, and decrease to shift in a negative direction.

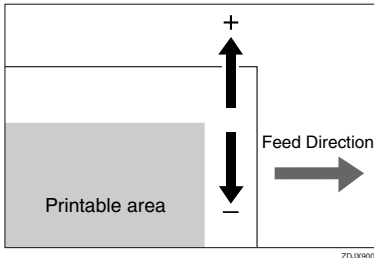

- Pressing **[▲]** or **[▼]** makes the value increase or decrease by 1.0 mm step.
- ⑤ Press **[Enter]**.
- ⑥ Press **[Escape]**.

The current setting is displayed for 2 seconds, and then the printer returns to the previous menu.

- ⑥ Print the test sheet to check the settings you have made.

- ⑦ Press **[On Line]**.

"Ready " appears on the panel display.

```
Ready
```

3. Paper and Other Media



Paper and Other Media Supported by This Printer

Paper Sizes

This section describes the type, size, feed direction, and maximum amount of paper that can be loaded into each paper tray in this printer.











Note

- The following symbols and terminology are used to represent the feed direction.

In this manual	On the panel display	Paper feed direction
 ← (Feed direction)	A4 (210 × 297) 8 1/2 × 11	Short-edge feed direction
 ← (Feed direction)	A4 (297 × 210) 11 × 8 1/2	Long-edge feed direction

- Be careful of the paper feed direction. The direction is determined for each paper size.

◆ Input Paper Sizes (Metric version)

	Feed direction	Size (mm)	Bypass tray	Paper Tray (Tray 1)	Paper Feed Unit (Tray 2/3/4)	2000-sheet Large Capacity Tray
A3		297 × 420	☆	×	◎	×
B4 JIS		257 × 364	☆	×	◎	×
A4		210 × 297	☆	×	◎	×
		297 × 210	☆	●	◎	●
B5 JIS		182 × 257	☆	×	☆	×
		257 × 182	☆	×	◎	×
A5		148 × 210	☆	×	×	×
		210 × 148	☆	×	◎	×
B6 JIS		128 × 182	★	×	×	×
A6		105 × 148	☆	×	×	×

	Feed direction	Size (mm)	Bypass tray	Paper Tray (Tray 1)	Paper Feed Unit (Tray 2/3/4)	2000-sheet Large Capacity Tray
11" × 17"	☞	279 × 432	☆	×	☉	×
Legal (LG, 8 ¹ / ₂ " × 14")	☞	216 × 356	☆	×	☆	×
Letter (LT, 8 ¹ / ₂ " × 11")	☞	216 × 279	☆	×	☆	×
	☞	279 × 216	☆	×	☉	×
5 ¹ / ₂ " × 8 ¹ / ₂ "	☞	140 × 216	☆	×	×	×
Executive (Exec., 7 ¹ / ₄ " × 10 ¹ / ₂ ")	☞	184 × 276	☆	×	☆	×
	☞	276 × 184	☆	×	×	×
Folio (8 ¹ / ₄ " × 13")	☞	210 × 330	☆	×	☆	×
Foolscap (F4, 8 ¹ / ₂ " × 13")	☞	216 × 330	☆	×	☆	×
F/GL (8" × 13")	☞	203 × 330	☆	×	☆	×
Com#10 Env (9 ¹ / ₂ " × 4 ¹ / ₈ ")	☞	241.3 × 104.8	☆	×	×	×
C5 Env (9.02" × 6.38")	☞	229 × 162	☆	×	×	×
C6 Env (6.38" × 4.49")	☞	162 × 114	☆	×	×	×
DL Env (8.66" × 4.33")	☞	220 × 110	☆	×	×	×
Monarch Env (7 ¹ / ₂ " × 3 ⁷ / ₈ ")	☞	190.5 × 98.4	☆	×	×	×
Custom Size	-	-	★*	×	×	×
8K (10 ¹ / ₂ " × 15.35")	☞	267 × 390	☆	×	☆	×
16K (7.68" × 10 ¹ / ₂ ")	☞	195 × 267	☆	×	☆	×
	☞	267 × 195	☆	×	☆	×

- means that the size is exclusive.
- ☉ means that the size is supported and printer select the paper size automatically.
- ☆ means that the size is supported but paper size should be selected with the control panel.
- ★ means that the size is supported but paper size should be set with the control panel as a custom size.
- ★* means that the supported size is approximately 90 - 305 mm in width, and approximately 148 - 458 mm in length. The supported size may differ depending on the printer language you use. Set the custom size setting with the control panel.
- × means that the size is not supported.

◆ Input Paper Sizes (Inch version)

	Feed direction	Size (inch)	Bypass Tray	Paper Tray (Tray 1)	Paper Feed Unit (Tray 2/3/4)	2000-sheet Large Capacity Tray
11" × 17"	☐	11" × 17"	☆	×	☉	×
Legal (LG)	☐	8 ¹ / ₂ " × 14"	☆	×	☉	×
Letter (LT)	☐	8 ¹ / ₂ " × 11"	☆	×	☉	×
	☐	11" × 8 ¹ / ₂ "	☆	●	☉	●
5 ¹ / ₂ " × 8 ¹ / ₂ "	☐	5 ¹ / ₂ " × 8 ¹ / ₂ "	☆	×	×	×
Executive (Exec.)	☐	7 ¹ / ₄ " × 10 ¹ / ₂ "	☆	×	☆	×
	☐	10 ¹ / ₂ " × 7 ¹ / ₄ "	☆	×	×	×
A3	☐	11.26" × 16.54"	☆	×	☉	×
B4 JIS	☐	10.12" × 14.33"	☆	×	☉	×
A4	☐	8.26" × 5.83"	☆	×	☉	×
	☐	5.83" × 8.26"	☆	●	☉	●
B5 JIS	☐	7.17" × 10.12"	☆	×	☆	×
	☐	10.12" × 7.17"	☆	×	☉	×
A5	☐	5.83" × 8.26"	☆	×	×	×
	☐	8.26" × 5.83"	☆	×	☉	×
B6 JIS	☐	5.04" × 7.17"	★	×	×	×
A6	☐	4.13" × 5.63"	☆	×	×	×
Folio	☐	13" × 8 ¹ / ₄ "	☆	×	☆	×
Foolscap F4	☐	13" × 8 ¹ / ₂ "	☆	×	☆	×
F/GL	☐	13" × 8"	☆	×	☆	×
Com#10 Env	☐	9 ¹ / ₂ " × 4 ¹ / ₈ "	☆	×	×	×
C5 Env	☐	9.02" × 6.38"	☆	×	×	×
C6 Env	☐	6.38" × 4.49"	☆	×	×	×
DL Env	☐	8.66" × 4.33"	☆	×	×	×
Monarch Env	☐	7 ¹ / ₂ " × 3 ⁷ / ₈ "	☆	×	×	×
Custom Size	-	-	★ [*]	×	×	×
8K	☐	10 ¹ / ₂ " × 15.35"	☆	×	☆	×
16K	☐	7.68" × 10 ¹ / ₂ "	☆	×	☆	×
	☐	10 ¹ / ₂ " × 7.68"	☆	×	☆	×







- means that the size is exclusive.
- ⊙ means that the size is supported and printer select the paper size automatically.
- ☆ means that the size is supported but the paper size should be selected with the control panel.
- ★ means that the size is supported but the paper size should be set with the control panel as a custom size.
- ★* means that the supported size is approximately 3.5 - 12 inch in width, and approximately 5.8 - 18 inch in length. The supported size may differ depending on the printer language you use. Set the custom size setting with the control panel.
- × means that the size is not supported.























◆ Paper weight and number of sheets to be set

	Supported paper weight	Maximum number of sheets (plain paper) *1
Tray 1	60 - 105 g/m ² (16 - 28 lb)	500 (80 g/m ² , 20 lb)
Tray 2	60 - 105 g/m ² (16 - 28 lb)	500 (80 g/m ² , 20 lb)
Bypass Tray	60 - 163 g/m ² (14 - 42 lb)	100 (80 g/m ² , 20 lb)
PAPER FEED UNIT Type 3800C (500 × 1)	60 - 105 g/m ² (16 - 28 lb)	500 (80 g/m ² , 20 lb)
PAPER FEED UNIT Type 3800C (500 × 2)	60 - 105 g/m ² (16 - 28 lb)	1000 (80 g/m ² , 20 lb)
Paper Bank PS470 (2000-sheet Large Capacity Tray)	60 - 105 g/m ² (16 - 28 lb)	2000 (80 g/m ² , 20 lb)
SR770 (2 Tray Finisher)	60 - 105 g/m ² (16 - 28 lb)	2000 (80 g/m ² , 20 lb)

*1 Confirm that the top of the stack is not higher than the limit mark inside the tray.





























◆ Output Paper Sizes (Metric version)

	Feed direction	Size (mm)	Standard Tray	Output Tray	2 Tray Finisher	4-bin Mailbox
A3		297 × 420	○	○	○	○
B4 JIS		257 × 364	○	○	○	○
A4		210 × 297	○	○	○	○
		297 × 210	○	○	○	○
B5 JIS		182 × 257	○	○	○	○
		257 × 182	○	○	○	○

	Feed direction	Size (mm)	Standard Tray	Output Tray	2 Tray Finisher	4-bin Mailbox
A5		148 × 210	○	○	×	○
	210 × 148	○		○	○	○
B6 JIS		128 × 182	○	○	×	×
A6		105 × 148	○	○	×	×
11" × 17"		279 × 432	○	○	○	○
Legal (LG, 8 ¹ / ₂ " × 14")		216 × 356	○	○	○	○
Letter (LT, 8 ¹ / ₂ " × 11")		216 × 279	○	○	○	○
		279 × 216	○	○	○	○
5 ¹ / ₂ " × 8 ¹ / ₂ "		140 × 216	○	○	×	×
Executive (Exec., 7 ¹ / ₄ " × 10 ¹ / ₂ "		184 × 276	○	○	○	○
		276 × 184	○	○	×	×
Folio (8 ¹ / ₄ " × 13")		210 × 330	○	○	○	×
Foolscap (F4, 8 ¹ / ₂ " × 13")		216 × 330	○	○	○	×
F/GL (8" × 13")		203 × 330	○	○	○	○
Com#10 Env (9 ¹ / ₂ " × 4 ¹ / ₈ ")		241.3 × 104.8	×	○	×	×
CA Env (9.02" × 6.38")		229 × 162	×	○	×	×
C6 Env (6.38" × 4.49")		162 × 114	×	○	×	×
DL Env (8.66" × 4.33")		220 × 110	×	○	×	×
Monarch Env (7 ¹ / ₂ " × 3 ⁷ / ₈ ")		190.5 × 98.4	×	○	×	×
Custom Size	-	-	○	○	×	○
8K (10 ¹ / ₂ " × 15.35")		267 × 390	○	○	○	×
16K (7.68" × 10 ¹ / ₂ "		195 × 267	○	○	○	○
		267 × 195	○	○	○	○

- ○ means that the size is supported.
- × means that the size is not supported.

◆ Output Paper Sizes (Inch version)

	Feed direction	Size (inch)	Standard Tray	Output Tray	2 Tray Finisher	4-bin Mailbox
11" × 17"		11" × 17"	○	○	○	○
Legal (LG)		8 ¹ / ₂ " × 14"	○	○	○	○
Letter (LT)		8 ¹ / ₂ " × 11"	○	○	○	○
		11" × 8 ¹ / ₂ "	○	○	○	○
5 ¹ / ₂ " × 8 ¹ / ₂ "		5 ¹ / ₂ " × 8 ¹ / ₂ "	○	○	×	×
Executive (Exec.)		7 ¹ / ₄ " × 10 ¹ / ₂ "	○	○	○	○
		10 ¹ / ₂ " × 7 ¹ / ₄ "	○	○	×	×
A3		11.26" × 16.54"	○	○	○	○
B4 JIS		10.12" × 14.33"	○	○	○	○
A4		8.26" × 5.83"	○	○	○	○
		5.83" × 8.26"	○	○	○	○
B5 JIS		7.17" × 10.12"	○	○	○	○
		10.12" × 7.17"	○	○	○	○
A5		5.83" × 8.26"	○	○	×	○
		8.26" × 5.83"	○	○	○	○
B6 JIS		5.04" × 7.17"	○	○	×	×
A6		4.13" × 5.63"	○	○	×	×
Folio		8 ¹ / ₄ " × 13"	○	○	○	×
Foolscap F4		8 ¹ / ₂ " × 13"	○	○	○	×
F/GL		8" × 13"	○	○	○	○
Com#10 Env		9 ¹ / ₂ " × 4 ¹ / ₈ "	×	○	×	×
C6 Env		6.38" × 4.49"	×	○	×	×
C5 Env		9.02" × 6.38"	×	○	×	×
DL Env		8.66" × 4.33"	×	○	×	×
Monarch Env		7 ¹ / ₂ " × 3 ⁷ / ₈ "	×	○	×	×
Custom Size	-	-	○	○	×	○
8K		10 ¹ / ₂ " × 15.35"	○	○	○	×
16K		7.68" × 10 ¹ / ₂ "	○	○	○	○
		10 ¹ / ₂ " × 7.68"	○	○	○	○

- ○ means that the size is supported and that the paper size should be set with the control panel. There is no dial in the tray.

- × means that the size is not supported.

Paper Recommendations

Loading Paper

Important

- Do not use paper that is meant for an ink-jet printer or it may stick to the Fusing Unit and cause a paper misfeed.
- When printing on an OHP transparency that has a print side, load it with the print side over on the Bypass Tray. Not taking this precaution may cause it to stick to the Fusing Unit and cause a misfeed.
- Print quality cannot be guaranteed if recommended paper is not used. For details about recommended paper, contact your sales or service representative.
- Do not use paper that has already been printed onto by other printers.

Storing Paper

- Paper should always be stored properly. Improperly stored paper might result in poor print quality, paper misfeeds, or printer damage. Recommendations are as follows:
 - Avoid storing paper in humid areas.
 - Avoid exposing paper to direct sunlight.
 - Store on a flat surface.
- Keep open reams of paper in the package in which the paper came.

Types of Paper and Other Media

❖ Plain Paper

- Tray 1/2 can hold up to 500 sheets.
PAPER FEED UNIT Type 3800C (500x1) can hold up to 500 sheets.
PAPER FEED UNIT Type 3800C (500x2) can hold up to 1000 sheets.
Paper Bank PS470 can hold up to 2000 sheets.
Confirm that the top of the stack is not higher than the limit mark inside the tray.
- Bypass Tray supports custom size, approximately 90 to 305 mm in width, and approximately 148 to 458 mm in length.
- When printing on the reverse side of plain paper that is already printed on, you should load it on the Bypass Tray and select **[Plain (Duplex Backside)]** from **[Paper Type:]** with the printer driver.

❖ Thick Paper

- Use the Bypass Tray.
- The Bypass Tray can hold paper up to 135 kg (163 g/m²) in weight. The print quality on paper that is thicker cannot be guaranteed.
- Confirm that the top of the stack is not higher than the limit mark inside the tray.
- When printing on thick paper, select thick paper mode with the printer driver.
- When printing on the reverse side of plain paper that is already printed on, you should load it on the Bypass Tray and select **[Thick (Duplex Backside)]** from **[Paper Type:]** with the printer driver.

Note

- ❑ The number of sheets to be set may vary depending on the paper thickness and paper type.

❖ OHP transparencies

- When printing on OHP transparencies, use the Bypass Tray.
- Load OHP transparencies on the tray with the print side over or they may stick to the Fusing Unit and cause a misfeed.
- Remove any unused OHP transparencies from the Bypass Tray after you are finished printing. Leaving them in the tray may cause them to stick together.
- When printing on OHP transparencies, you should select the OHP transparency mode with the printer driver.
- Confirm that the top of the stack is not higher than the limit mark inside the tray.
- When you print OHP transparencies more than one copies, remove each sheet from the tray one by one before next sheet is printed out, or select "Slip Sheet" in the printer driver. For details about using "Slip Sheet", see the printer driver Help file.

◆ Envelopes

⚠ Important

☐ Only envelopes ① and ② as shown below are supported.

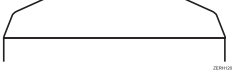
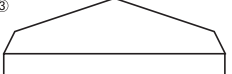
<p>①</p> 	Supported ^{*1}
<p>②</p> 	Supported ^{*1}
<p>③</p> 	Not supported

^{*1} Misfeeds also might occur when using envelopes ① and ② depending on the length and shape of the flaps.

- When printing on envelopes, use the bypass tray, and select "Thick Paper" as a paper type in the "Paper Input" menu on the control panel.
⇒ p.67 "Specifying a paper type for the Bypass Tray"
- Specifications of envelopes are as follows:

	Metric version	Inch version
Weight	72 - 90 g/m ²	19 - 24 lb
Recommended weight and size	72 g/m ² , 114 × 162 mm (C6 Env)	24 lb, 3 ⁷ / ₈ " × 7 ¹ / ₂ " (Monarch)

- You can load up to 10 envelopes (72 - 92 g/m², 19 - 24 lb) in the Bypass Tray at the same time, without forcibly pressing them. Confirm that the envelopes are not damp, and that the top of the stack is not higher than the limit mark on the side guide.
- Confirm that the print side is facing up when loading onto the Bypass Tray.
- When loading envelopes, be sure to unfold the flaps and position them opposite to the paper feed direction.

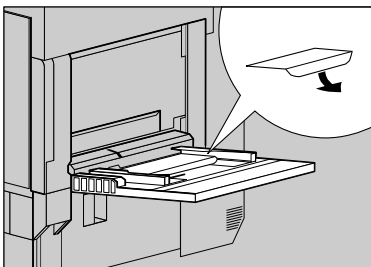

ZGBH020N

- Make the printer driver's setting for rotating the print image by 180 degrees. For details, see the Help file for the printer driver.
- Confirm that there is no air in the envelopes before loading.
- To get better print quality, it is recommended that you set the right, left, top, and bottom print margin, to at least 15 mm (0.6") each.
- Do not print on both sides of envelopes.
- Load only one size and type of envelopes at the same time.
- Before loading envelopes, flatten the leading edges (the side being fed into the printer) of them by running a pencil or ruler across them.
- Before loading envelopes, confirm that they are rectangular in shape.
- Supported size of envelope is listed on p.47 "Paper and Other Media".

◆ **Paper not supported by this printer**

Avoid using the following types of paper that are not supported by this printer:

- Paper meant for an ink-jet printer
- Bent, folded, or creased paper
- Curled or twisted paper
- Torn paper
- Wrinkled paper
- Damp paper
- Paper that is dry enough to emit static electricity
- Paper that has already been printed onto, except a preprinted letterhead
- Coated paper
- Special paper, such as thermal paper, aluminum foil, carbon paper and conductive paper
- Paper whose weight is heavier or lighter than the limitation.
- With windows, holes, perforations, cutouts, or embossing
- Label paper on which glue or base paper is exposed
- Paper with clips or staples

Printable Area

The following shows the printable area for this printer. Be sure to set the print margins correctly by the application.

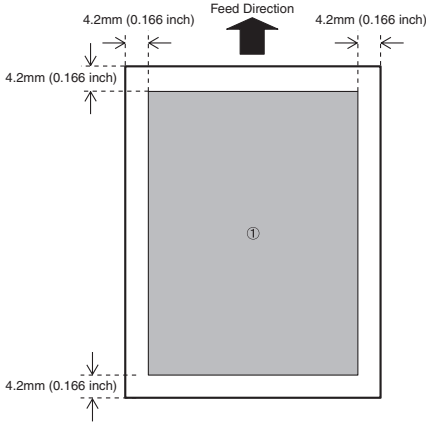

① : printable area

 **Note**

- ❑ The printable area may vary depending on the paper size, printer language and printer driver settings.

Loading Paper

Load paper and change the paper size in Tray 1, Tray 2 and the optional Paper Feed Unit by following the procedures below.

Important

- ❑ Tray 1 uses A4 paper exclusively. Load only A4 paper at all times.
- ❑ 2000-sheet Large Capacity Tray uses A4 paper exclusively. Load only A4 paper at all times.
- ❑ If you want to load Letter-sized paper (11 × 8 1/2) in Tray 1 and optional 2000-sheet Large Capacity Tray, contact your sales or service representative.

Reference

See p.47 “Paper Sizes” concerning paper to be loaded in the Paper Tray and optional Paper Feed Unit.

3

Loading Paper in Tray 1

Important

- ❑ Tray 1 uses A4 paper exclusively. Load only A4 paper at all times.
- ❑ If you want to load Letter-sized paper (11 × 8 1/2) in Tray 1, contact your sales or service representative.

- 1** Pull out the paper tray slowly until it stops.

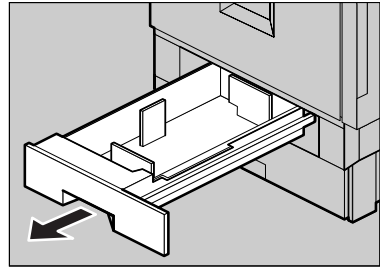

ZD.JH003J

- 2** Load paper into the tray with the print side down.

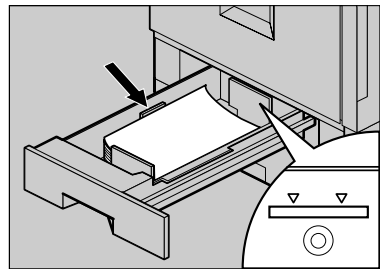

ZD.JY001J

Important

- ❑ Confirm that the top of the stack is not higher than the limit mark inside the tray.

- 3** Carefully slide the paper tray into the printer until it stops.

Loading Paper in Tray 2 and the Optional Paper Feed Unit

This section describes loading paper which is different from default size in Tray 2.

- 1** Pull out the Paper Tray slowly until it stops.

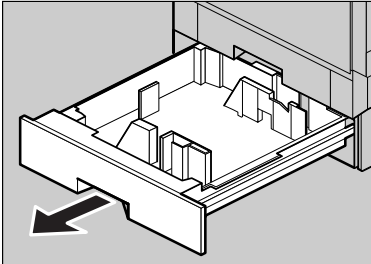

ZDJH005J

- 2** Set the paper guide lock to the "unlocked" position.

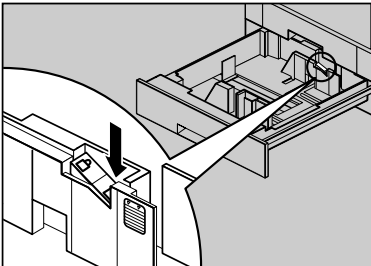

ZDJY003J

- 3** Pushing the green lever of the side guide (①), move the side guide toward you to open it (②).

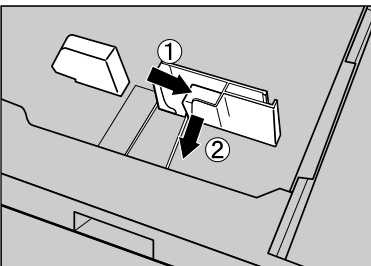

ZDJY802J

- 4** Pinching both sides of the end guide (①), move the end guide in the direction of the arrow to open it.

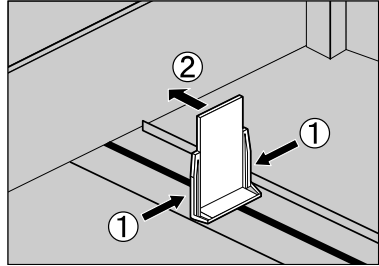

ZDJY801J

- 5** Load paper in the same direction.

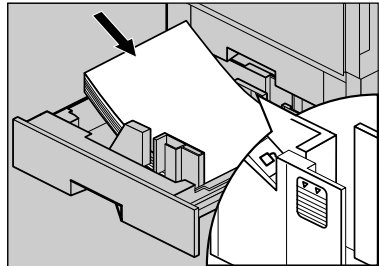

ZDJY002J

Important

- Confirm that the top of the stack is not higher than the limit mark inside the tray.

- 6** Pushing the green lever of the side guide (①), move the side guide toward the paper stack until it stops (②).

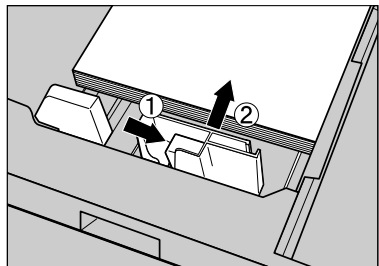

ZDJY006J

- 7** Make sure the paper is fixed in place, and then lock the side guide.

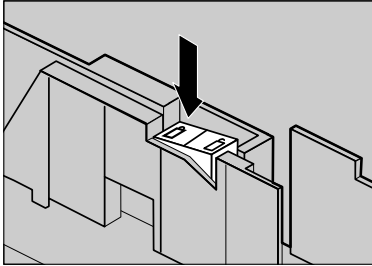

3

- 8** Pinching both sides of the end guide (①), move the end guide toward the paper stack until it stops (②).

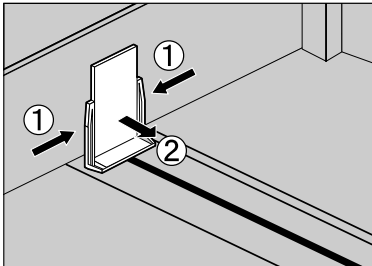

- 9** Carefully slide the paper tray into the printer until it stops.

Important

- Do not slide the paper tray in with force. If you do, the front and side guides might move.

Loading paper in Paper Bank PS470 (2000-sheet Large Capacity Tray)

Important

- 2000-sheet Large Capacity Tray uses A4 paper exclusively. Load only A4 paper at all times.
- If you want to load Letter-sized paper (11 × 8 1/2) in the 2000-sheet Large Capacity Tray, contact your sales or service representative.

- 1** Pull out the Paper Tray slowly until it stops.

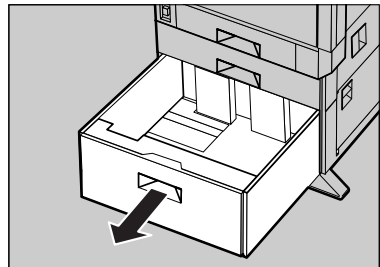

- 2** With the print side down, align all four sides of two paper stacks, and then load them next to each other in the tray. Each side has a limit of 1,000 sheets.

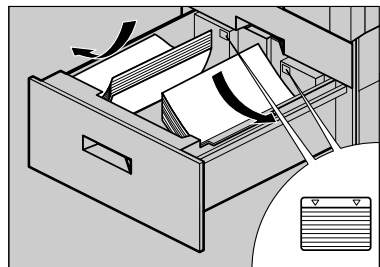

Important

- Align the paper and load them against the left and right walls, or a paper misfeed might occur.
- Confirm that the top of the stack is not higher than the limit mark inside the tray.

- 3** Push in the Paper Tray slowly until it stops.

If you load a paper size that is not selected automatically

Note

- Paper sizes that are not selected automatically are B5, $8\frac{1}{2} \times 14$, $8\frac{1}{2} \times 11$, $7\frac{1}{4} \times 10\frac{1}{2}$, 8×13 , $8\frac{1}{2} \times 13$, $8\frac{1}{4} \times 13$, 8K ($10\frac{1}{2} \times 15.35$), 16K ($7.68 \times 10\frac{1}{2}$), 16K ($10\frac{1}{2} \times 7.68$).

Reference

See p.59 "Loading Paper in Tray 2 and the Optional Paper Feed Unit" for details about how to load the paper.

Important

- Tray 1 uses A4 paper exclusively. Load only A4 paper at all times.
- Paper Bank PS470 uses A4 paper exclusively. Load only A4 paper at all times.
- If you want to load Letter-sized paper ($11 \times 8\frac{1}{2}$) in Tray 1 and optional Paper Bank PS470, contact your sales or service representative.

This section uses Letter ($8\frac{1}{2} \times 11$) as an example.

- 1** Press **[Menu]**.

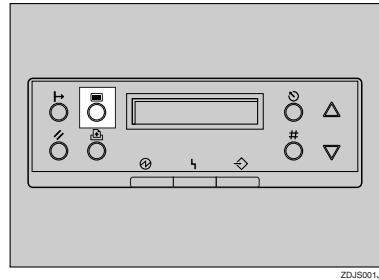

"Menu" appears on the panel display.

- 2** Press **[▲]** or **[▼]** to display "Paper Input", and then press **[Enter]**.



The paper selection menu is displayed.

- 3** Press **[▲]** or **[▼]** to display "Tray Paper Size", and then press **[Enter]**.

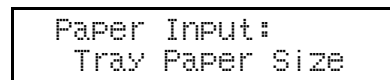

The paper tray selection menu is displayed.

- 4** Press **[▲]** or **[▼]** to display the target paper tray, and then press **[Enter]**.



The paper size selection menu is displayed.

- 5** Press **[▲]** or **[▼]** to display the loaded paper size, and then press **[Enter]**.



After about two seconds, the display is returned to the menu.

- 6** Press **[On Line]**.

"Ready " appears on the panel display.



This completes the change in setting.

Important

- After printing on a paper size that is not selected automatically, if you want to print on paper that is selected automatically again, reload the paper, proceed to step **7**, and return the setting to "Auto".

- 7** Press **[Menu]**.

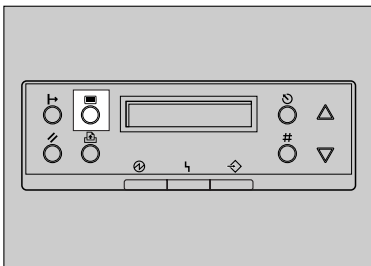

"Menu" appears on the panel display.

- 8** Press **[▲]** or **[▼]** to display "Paper Input", and then press **[Enter]**.



The paper selection menu is displayed.

- 9** Press **[▲]** or **[▼]** to display "Tray Paper Size", and then press **[Enter]**.

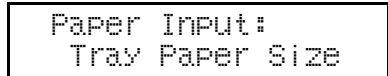

The paper tray selection menu is displayed.

- 10** Press **[▲]** or **[▼]** to display the target paper tray, and then press **[Enter]**.

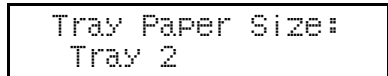

The paper size selection menu is displayed.

- 11** Press **[▲]** or **[▼]** to display "~~*~~Auto", and then press **[Enter]**.

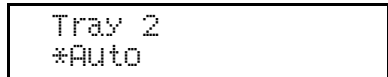

After about two seconds, the display is returned to the menu.

- 12** Press **[On Line]**.

"Ready " appears on the panel display.

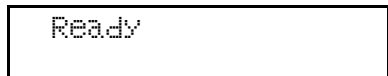

Changing the paper type

By selecting the paper type you want to load, the printer can execute better printing. You can select from the following paper types.

- Plain Paper, Recycled Paper, Special Paper, Color Paper, Letterhead Paper, Preprinted Paper, Pre-punched Paper, Bond Paper, Card Stock

- 1 Press **[Menu]**.

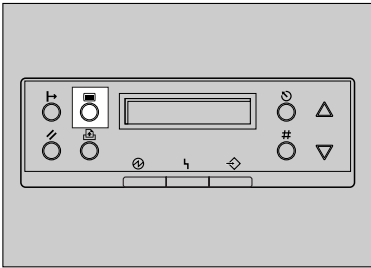

ZDJ5001J

"Menu" appears on the panel display.

- 2 Press **[▲]** or **[▼]** to display "Paper Input", and then press **[Enter]**.

```
Menu:
Paper Input
```

The paper selection menu is displayed.

- 3 Press **[▲]** or **[▼]** to display "Paper Type", and then press **[Enter]**.

```
Paper Input:
Paper Type
```

The paper tray selection menu is displayed.

- 4 Press **[▲]** or **[▼]** to display the target paper tray, and then press **[Enter]**.

```
Paper Type:
Tray 2
```

The paper type selection menu is displayed.

- 5 Press **[▲]** or **[▼]** to display the loaded paper type, and then press **[Enter]**.

```
Tray 2
Recycled Paper
```

After about two seconds, the display is returned to the menu.

- 6 Press **[On Line]**.

"Ready" appears on the panel display.

```
Ready
```

Load Paper in the Bypass Tray

Besides regular paper, you can load thick paper, envelopes, OHP transparencies, and paper that is longer than A3 onto the Bypass Tray, which cannot be loaded in the Paper Trays or Paper Feed Unit.

Note

- 3**
- ❑ Paper sizes supported by the Bypass Tray are 90 - 305 mm in width, and 148 - 458 mm in length.
 - ❑ If you load custom size paper or special paper, select the paper size with the control panel. The RPCS printer driver can select the paper size with the printer driver properties. The paper size selected with the printer driver overrides the one selected with the control panel. See p.66 "Specifying a custom paper size for the Bypass Tray".
 - ❑ If you load thick paper, OHP transparencies, or envelopes, make the settings for thick paper or OHP transparencies with the control panel or printer driver. See p.67 "Specifying a paper type for the Bypass Tray".
 - ❑ The number of pages that can be loaded in the Bypass Tray differs depending on the paper type. Confirm that the top of the stack is not higher than the limit mark inside the tray.

Limitation

- ❑ You cannot use the following functions when printing on paper that is loaded in the Bypass Tray.
 - Duplex Print
 - Collate, Job Separation
 - Staple/Punch
 - Auto Tray Select

1 Open the bypass tray.

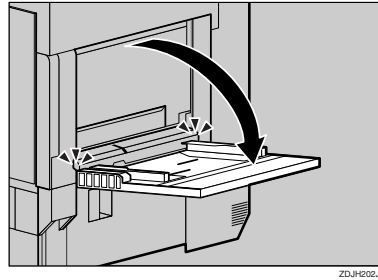

ZDJH202J

Note

- ❑ If you load A4 or larger size paper, pull out the bypass tray extension, and then flip it open.

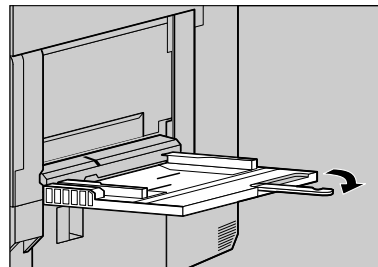

ZDJH203J

- 2** Slide the side guides outward (①), and then load paper until it stops with the print side up (②).

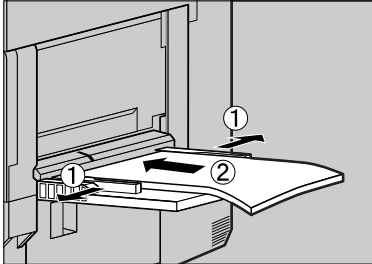

ZD/JH204J

- 3** Adjust the side guides to the paper width.

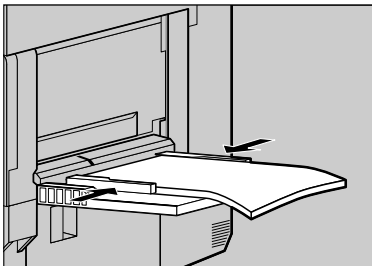

ZD/JH205J

Important

- Confirm that the top of the stack is not higher than the limit mark inside the tray.
- Shuffle the paper before loading the stack onto the tray so multiple sheets are not fed in at one time.

- 4** Set the paper size using the control panel as follows:

- 1** Press **[Menu]**.

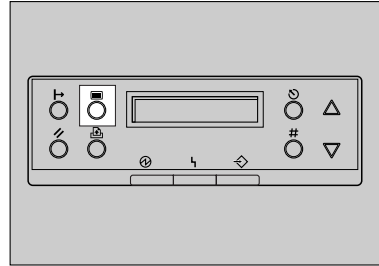

ZD/JS001J

"Menu" appears on the panel display

- 2** Press **[▲]** or **[▼]** to "Paper Input" menu, and then press **[Enter]**.

The following message appears on the panel display.

```
Menu:
Paper Input
```

- 3** Confirm that "Bypass Size" is displayed, and then press **[Enter]**.

The following message appears on the panel display.

```
Paper Input:
Bypass Size
```

- 4** Press **[▲]** or **[▼]** to display the size and direction of the paper in the bypass tray.

```
Bypass Size
*11 x 17
```

After about two seconds, the display is returned to the menu.

5 Press [On Line].

"Ready " appears on the panel display.



Specifying a custom paper size for the Bypass Tray

3

Important

- ❑ The paper size selected with the printer driver overrides the one selected with the control panel. You do not have to make settings with the control panel if you already made them with the printer driver. However, when printing with a printer driver other than the RPCS printer driver, you must make the settings using the control panel. For more information about the printer driver, see the Help Files.
- ❑ The printer cannot print from applications that do not supports custom paper size.

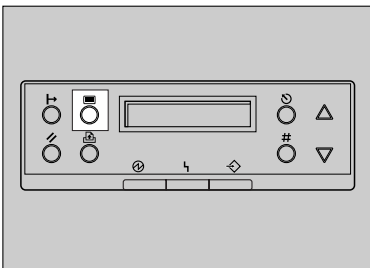
1 Press [Menu].

ZDJ5001J

"Menu" appears on the panel display.

2 Press [▲] or [▼] to display "Paper Input", and then press [Enter].

The following message appears on the panel display.

**3 Confirm that "Bypass Size" is displayed, and then press [Enter].**

The following message appears on the panel display.

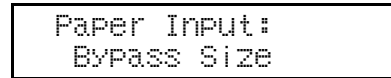
**4 Press [▲] or [▼] to display "Custom Size", and then press [Enter].**

The following message appears on the panel display.

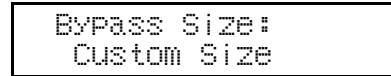
**5 Press [▲] or [▼] to set the horizontal value, and then press [Enter].**

The following message appears on the panel display.

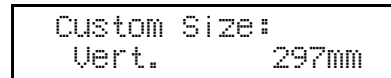
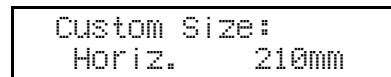
**6 Press [▲] or [▼] to set the vertical value, and then press [Enter].**

After about two seconds, the display is returned to the menu.

7 Press **[On Line]**.

The following message appears on the panel display.



Specifying a paper type for the Bypass Tray

By selecting the paper type you want to load, the printer can execute better printing. You can select from the following paper types.

- Plain Paper, Recycled Paper, Special Paper, Color Paper, Letterhead, Preprinted, Prepunched, Labels, Bond Paper, Card Stock, OHP Transparencies, Thick Paper, Plain Paper (Duplex), Thick Paper (Duplex)

Important

- Be sure to select the paper type when you load labels, thick paper, or OHP transparencies in the Bypass Tray.

Limitation

- You cannot use the following functions when printing on paper loaded in the Bypass Tray.
 - Duplex Print
 - Collate, Job Separation
 - Staple, Punch
 - Auto Tray Select

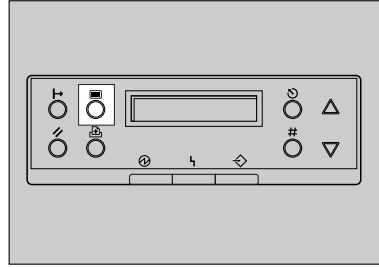
1 Press **[Menu]**.

"Menu" appears on the panel display.

2 Press **[▲]** or **[▼]** to display "Paper Input", and then press **[Enter]**.

The following message appears on the panel display.

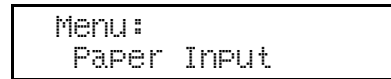
**3** Press **[▲]** or **[▼]** to display "Paper Type", and then press **[Enter]**.

The following message appears on the panel display.

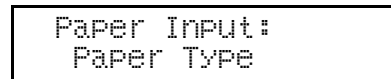
**4** Press **[▲]** or **[▼]** to display "Bypass Tray", and then press **[Enter]**.

The following message appears on the panel display.

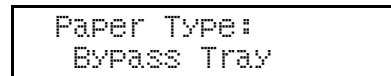

- 5** Press **[▲]** or **[▼]** to display the target paper type, and then press **[Enter]**.



```
Bypass Tray:  
*Thick Paper
```

After about two seconds, the display is returned to the menu.

- 6** Press **[On Line]**.

The following message appears on the panel display.



```
Ready
```

4. Troubleshooting

Error & Status Messages on the Control Panel

◆ Status Messages

Messages/Second messages	Description	Solution
Calibrating...	The printer is calibrating the color.	Wait for a while.
Energy Save Mode	In Energy Save Mode Level 2.	No action required.
Hex Dump Mode	In Hex Dump Mode.	No action required.
Loading Toner...	The printer is loading the toner.	Wait for a while.
Offline	The printer is offline and cannot print data.	Press [On Line] .
Initializing... Please Wait	The printer is initializing the development unit.	Wait for a while.
Printing...	The printer is doing print job.	Wait for a while.
Processing...	Print data is being processed.	Wait for a while.
Ready	The default ready message. The printer is ready to use.	No action required.
Resetting Job...	Job is being reset.	Wait for a while.
Waiting...	The printer is waiting for the next data to print.	Wait for a while.
Warming Up...	The printer is warming up and not ready.	Wait until the printer signals Ready.

◆ Alert Messages

Messages/Second messages	Description	Solution
Add Staples	The stapler is out of staples. Job is not stapled.	Replace new staples. See p.100 "Adding Staples".
Add Toner/Yellow/Magenta/Cyan/Black	The printer is out of the indicated toner(s).	Replace a new toner cartridge of the indicated color(s). See p.1 "Replacing Consumables and Maintenance Kit".
Add Toner Black	The printer is out of toner (K).	Replace a new toner cartridge (K). See p.1 "Replacing Consumables and Maintenance Kit".

Messages/Second messages	Description	Solution
Add Toner Cyan	The printer is out of toner (C).	Replace a new toner cartridge (C). See p.1 "Replacing Consumables and Maintenance Kit".
Add Toner Magenta	The printer is out of toner (M).	Replace a new toner cartridge (M). See p.1 "Replacing Consumables and Maintenance Kit".
Add Toner Yellow	The printer is out of toner (Y).	Replace a new toner cartridge (Y). See p.1 "Replacing Consumables and Maintenance Kit".
Call Service: EC Power Off On /If Error Reoccur Call Service	A communication error sent from the engine to the controller.	Turn the power switch off and then on. If the message appears again, contact your sales or service representative.
Change Setting Tray # /Paper Size: Paper Type:	The paper size and type setting in the tray differs from that of actual paper size and type in the tray.	Load [paper size and type] paper with the selected feed direction into the tray, and then change the paper size and type with the control panel. Or press [Form Feed] , and then select the tray with the operational panel. Or press [Job Reset] to cancel the print job.
Close Duplex Unit Cover	The cover for the duplex unit is open.	Close the cover for the duplex unit.
Close Finisher Front Cover	The front cover for the finisher is open.	Close the front cover for finisher.
Close Right Cover	The upper right cover (the cover for the toner cartridge) is open.	Close the upper right cover.
Close Finisher Upper Cover	The finisher upper cover is open.	Close the upper cover for the finisher.
Close Finisher Upper Cover	The paper entrance cover for the finisher is open.	Close the upper entrance cover for the finisher.
Close Front Cover	The front cover is open.	Close the front cover for the printer.
Close Lower Right Cover	The right cover for the paper feed table/large capacity tray is open.	Close the right cover for the paper feed table/large capacity tray.
Close Mailbox Cover	The cover for 4-bin Mailbox is open.	Close the cover for the 4-bin Mailbox tray.

Messages/Second messages	Description	Solution
Close Right Cover	The right cover is open.	Close the right cover.
Close Upper Left Cover	The upper left cover (the cover for the fusing unit) is open.	Close the upper left cover.
Driver Setting Error (Memory)	The printer identified a download error. This error may occur when the installed memory amount is less than the driver setting.	Verify that the paper memory size is specified with the driver setting.
Duplex Cancelled	The setting of Duplex Print has been cancelled.	(a) To print the image correctly, add memory to the printer. (b) Be sure to use the correct paper.
Error:Tray 1 Reset The Job /Then Power OffOn	There is a problem with the current specified tray. The job can not be processed.	Reset the job then turn the printer Off, and then back On.
Error:Tray 1 Form Feed /Or Job Reset Then Power OffOn	The printer identified the failure of the indicated paper tray. The job is not printed.	Apply Form Feed from other tray or cancel the job, and then switch your printer Off then back On. If the error continues, contact your sales or service representative.
Exceeded Max. Pages (Collate)	The printer identified a collation page overflow error.	Increase the RAM capacity.
		Install the optional hard disk drive.
Exceeded Max. Stored Files	The maximum number of stored files has been exceeded during Sample Print of Lacked Print.	Delete the stored files.
Exceeded Max. Stored Pages	The maximum number of pages has been exceeded during Sample Print of Lacked Print	Reduce the number of pages to print.
Hardware Problem DIMM	The printer identified a DIMM sum value error.	Remove and re-install the DIMM correctly. Remove any dust under the DIMM. If the message appears again, contact your sales or service representative. See " <i>Setting Up</i> " in the Setup Guide.
Hardware Problem Ethernet	The printer identified an Ethernet error.	Turn the power switch off and then on. If the message appears again, contact your sales or service representative.

Messages/Second messages	Description	Solution
Hardware Problem Finisher	There is a problem with the finisher.	Turn the power switch off and then on. If the message appears again, contact your sales or service representative.
Hardware Problem HDD	The printer identified a HDD Board error.	Remove and re-install the HDD Board correctly. If the message appears again, contact your sales or service representative. See " <i>Setting Up</i> " in the Setup Guide.
Hardware Problem IEEE1394	The printer identified an IEEE1394 Board error.	Remove and re-install the IEEE1394 Board correctly. <ol style="list-style-type: none"> ① Confirm that the 1394 Interface Unit Type1045 is attached to the computer correctly. ② Confirm that the IEEE1394 interface cable is connected securely. ③ Unplug the IEEE1394 interface cable which is connected to the printer. ④ Restart the computer. If the message appears again even after executing above operation, proceed to the following steps. ⑤ Execute the utility tool for 1394 Interface Unit Type1045 which is stored in the following path in the CD-ROM labeled "Printer Drivers and Utilities". UTILITY\1394 <p>Important</p> <ul style="list-style-type: none"> <input type="checkbox"/> For details about using the utility tool for IEEE1394, see the README file in the same directory in the CD-ROM. <p>If the message appears again, contact your sales or service representative. See "<i>Setting Up</i>" in the Setup Guide.</p>

Messages/Second messages	Description	Solution
Hardware Problem NV-RAM	The printer identified a Memory Switch (User Account Enhance Unit) error.	Replace the User Account Enhance Unit.
Hardware Problem Option RAM	The printer identified an optional RAM error.	Remove and re-install the optional RAM. If the message appears again, contact your sales or service representative.
Hardware Problem Parallel I/F	There is a problem with the parallel interface.	If you use the parallel I/F, replace the interface cable that caused the error. If the message appears again, contact your sales or service representative.
Hardware Problem Staple Unit	There is misfeed in the finisher or there is a problem with the staple unit failure.	Remove the misfeed. If the message appears again, contact your sales or service representative. See p.94 "When "Remove Misfeed R: Finisher" Appears". See p.98 "Removing Jammed Staples".
Hardware Problem Tray 1	There is a problem with the paper lift motor of the Tray 1.	Turn the power switch off and then on. If the message appears again, contact your sales or service representative.
Hardware Problem Tray 2	There is a problem with the paper lift motor of the Tray 2.	Turn the power switch off and then on. If the message appears again, contact your sales or service representative.
Hardware Problem Tray 3	There is a problem with the paper lift motor of the paper tray 3.	Align paper and set them in the collect position in the paper tray 3.
		Turn the power switch off and then on. If the message appears again, contact your sales or service representative.
Hardware Problem Tray 4	There is a problem with the paper lift motor of the paper tray 4.	Turn the power switch off and then on. If the message appears again, contact your sales or service representative.

Messages/Second messages	Description	Solution
HDD Full	The maximum HDD area size for form/font has been exceeded.	Delete the disused form /font types.
	An HDD overflow error occurred during Sample Print or Lacked Print.	Delete the stored files or reduce the size of the Sample Print file or Lacked Print file.
HDD Not Installed	The user tries to print the Lacked Print data without HDD installed.	If you use the Locked Print feature, make sure to install HDD. If the error continues, contact your sales or service representative.
I/O Buffer Overflow	The maximum size of the I/O buffer has been exceeded.	Increase the size of the I/O buffer through the I/F Setup.
Invalid Password Try Again	The entered password with the control panel is not correct.	Enter the correct password with the control panel.
Load Correct Size Paper /Press # To Continue	The paper size setting in the tray differs from that of actual paper size in the tray.	Load {paper size} paper with the selected feed direction into the tray, and then change the paper size with the control panel. Or press 【Form Feed】 , and select the tray with the operational panel. Or press 【Job Reset】 to cancel the print job.
Load Paper Tray #	The indicated tray is out of paper. #: tray number	Load paper into the indicated paper tray.
Load Paper /Paper Size: Paper Type:	1:The printer received a request for a paper type, or paper size not available in the printer, and Tray Locking is not applicable. 2:The paper type and size loaded in the tray which the printer searched using Tray Locking is Invalid for Duplex Print.	Change the setting of the indicated paper input tray, or press 【Job Reset】 . Form Feed is not applicable here.
Menu Protected Cannot Change	The menu is protected and the setting cannot be changed.	Wait for two seconds until the previous display appears.
No Files Exist	There are no files available for Sample Print job or Locked Print job.	Wait for two seconds until the previous display appears.

Messages/Second messages	Description	Solution
P=07 I=9Fc01234 Power Off On /If Error Reoccur Call Service	A controller error. The SC number indicates the problem.	Turn the power switch off and then on. If the message appears again, contact your sales or service representative.
Paper Invalid for Duplex:Tray# /Change Setting or Form Feed	The printer detected the setting of the indicated tray is invalid for Duplex Tray. #: tray number	Change the setting of the indicated paper input tray or apply Form Feed using another tray, or press [Job Reset] .
Punch-hole Chips are Full	The Punch Chips is full of punch chips.	Remove the punch chips from the punch wast box. See p.102 "Removing Punch-hole Chips"
		When the message appears even the punch wast box is not full, remove the Punch-hole chips on the top of the punchwast box. See ⇒ p.102 "When the message appears even after removing the Punch-hole chips"
Remove MisfeedA:Internal Path /See Instructions in Front Cover	There is a misfeed in the printer.	Remove the misfed paper following the instructions inside the front cover. For more information, see p.92 "When "Remove Misfeed A:Internal Path" Appears".
Remove MisfeedB: Fusing Unit /See Instructions in Front Cover	There is a misfeed in the fusing unit.	Remove the misfed paper following the instructions inside the front cover. For more information, see p.92 "When "Remove Misfeed B: Fusing Unit" Appears".
Remove MisfeedR: Finisher /Open Front Cover	There is a misfeed in the finisher.	Open the finisher cover and remove misfeed. For more information, see p.94 "When "Remove Misfeed R: Finisher" Appears".
Remove MisfeedW: Mailbox /Open Mailbox Cover	There is a misfeed in the output 4-bin tray.	Open the mailbox cover and remove misfeed. For more information, see p.94 "When "Remove Misfeed W: Mailbox" Appears".

Messages/Second messages	Description	Solution
Remove MisfeedY: Paper Tray /See Instructions in Front Cover	There is a misfeed in the specified input tray, or the printer is not feeding paper.	Remove the misfed paper following the instructions inside the front cover. For more information, see p.96 "When "Remove Misfeed Y: Paper Tray" Appears".
Remove Misfeed: Duplex Unit /See Instructions in Front Cover	There is a misfeed in the duplex unit.	Remove the misfed paper following the instructions inside the front cover. For more information, see p.96 "When "Remove Misfeed :Duplex Unit " Appears".
Remove Misfeed: Dup.Feed Unit /See Instructions in Front Cover	There is a misfeed in the duplex feed unit.	Remove the misfed paper. See p.89 "Removing Misfed Paper in the Duplex Feed Unit".
Remove Paper All Output Trays	All output trays are full.	Remove paper from all output trays.
Remove Paper Finisher Tray #	The indicated finisher shift tray is full. #:finisher shift tray number	Remove the paper from the indicated finisher shift tray.
Remove Paper From Upper Tray	The upper tray (output 1-bin tray)is full.	Remove paper from the upper tray.
Remove Paper Inside Finisher	There is still paper in the finisher.	Open the cover for the finisher and remove paper. See p.94 "When "Remove Misfeed R: Finisher" Appears".
Remove Paper Inside Finisher	A communication error is sent from the system unit to the duplex unit.	Remove and re-install the duplex unit. If the problem continues, contact your sales or service representative.
Remove Paper Mailbox Tray #	The output tray # of the optional 4-bin Mailbox is full. #:mailbox tray number	Remove paper from the indicated 4-bin Mailbox tray.
Remove Paper Standard Tray	The standard output tray is full	Remove paper from standard output trays.
Replace Black Dev. Unit(TypeD)	It is time to replace the black development unit.	Replace a new black development unit. Depending on your service contract, contact your sales or service representative. See p.1 "Replacing Consumables and Maintenance Kit".

Messages/Second messages	Description	Solution
Replace Black PCU (Type F)	It is time to replace the black PCU.	Replace a new black PCU. Depending on your service contract, contact your sales or service representative. See p.1 "Replacing Consumables and Maintenance Kit".
Replace Color Dev. Unit(TypeB)	It is time to replace the color development unit.	Replace a new color development unit. Depending on your service contract, contact your sales or service representative. See p.1 "Replacing Consumables and Maintenance Kit".
Replace Color PCU (Type A)	It is time to replace the color PCU.	Replace a new color PCU. Depending on your service contract, contact your sales or service representative. See p.1 "Replacing Consumables and Maintenance Kit".
Replace Fuser Oil Unit (TypeG)	It is time to replace the fuser oil unit.	Replace a new fuser oil unit. Depending on your service contract, contact your sales or service representative. See p.1 "Replacing Consumables and Maintenance Kit".
Replace FuserOil Unit soon (TypeG)	The fuser oil unit should be replaced soon.	Prepare a new fuser oil unit.Depend on your service contract, contact your sales or service representative. See p.1 "Replacing Consumables and Maintenance Kit".
Replace Fusing Unit (Type C)	It is time to replace the fusing unit.	Replace a new fusing unit. Depending on your service contract, contact your sales or service representative. See p.1 "Replacing Consumables and Maintenance Kit".
Replace Fusing Unit soon (TypeC)	The fusing unit should be replaced soon.	Prepare a new fusing unit.De- pending on your service contract, contact your sales or service representative. See p.1 "Replacing Consumables and Maintenance Kit".

Messages/Second messages	Description	Solution
Replace Waste Toner (Type E)	It is time to replace the waste toner.	Replace a waste toner bottle. Depending on your service contract, contact your sales or service representative. See p.1 "Replacing Consumables and Maintenance Kit".
Reset Cyan Toner Correctly	The toner cartridge (C) is not set correctly or is not set, and the color printing is non-applicable.	Set the toner cartridge (C) correctly. See "Setting Up" in the Setup Guide.
Reset Develop. Unit Correctly /Yellow/Magenta Cyan/Black	The indicated development unit(s) is/are not set correctly, or is not set.	Set the indicated development unit(s) correctly. See p.1 "Replacing Consumables and Maintenance Kit".
Reset Duplex Unit Correctly	The duplex paper feed unit is not set correctly or is not set.	Remove and re-install the duplex paper feed unit. If the error continues, contact your sales or service representative. See "Setting Up" in the Setup Guide.
Reset Finisher Correctly	Finisher is not set correctly, or is not set.	Set the finisher correctly. See "Setting Up" in the Setup Guide.
Reset Fuser Oil Unit Correctly	The fuser oil unit is not set correctly, or is not set.	Set the fuse oil unit correctly. See p.1 "Replacing Consumables and Maintenance Kit".
Reset Fusing Unit Correctly	There is no fusing unit, or the fusing unit is not installed correctly.	Set the fusing unit correctly. See p.1 "Replacing Consumables and Maintenance Kit".
Reset Magenta Toner Correctly	The toner cartridge (M) is not set correctly or is not set, and the color printing is non-applicable.	Set the toner cartridge (M) correctly. See "Setting Up" in the Setup Guide.
Reset PCU Correctly /Yellow/Magenta Cyan/Black	The indicated Photoconductor Unit(s) is/are not set correctly, or is not set.	Set the indicated Photoconductor Unit(s) correctly. See p.1 "Replacing Consumables and Maintenance Kit".
Reset Toner Black	The indicated toner cartridge is not set correctly.	Set the indicated toner cartridge(s) correctly. See "Setting Up" in the Setup Guide.

Messages/Second messages	Description	Solution
Reset Toner Cyan	The indicated toner cartridge is not set correctly.	Set the indicated toner cartridge(s) correctly. See " <i>Setting Up</i> " in the Setup Guide.
Reset Toner Magenta	The indicated toner cartridge is not set correctly.	Set the indicated toner cartridge(s) correctly. See " <i>Setting Up</i> " in the Setup Guide.
Reset Toner Yellow	The indicated toner cartridge is not set correctly.	Set the indicated toner cartridge(s) correctly. See " <i>Setting Up</i> " in the Setup Guide.
Reset Transfer Unit Correctly	The transfer unit is not set correctly, or is not set.	Contact your sales or service representative.
Reset Tray 1 Correctly	The indicated paper input tray is not set correctly, or is not set.	Set the indicated paper input tray correctly.
Reset Tray Correctly	The printer detected, when processing a job through Auto Tray Select, that any of paper input tray is not set correctly, or is not set.	Set the indicated paper input tray correctly.
Reset Waste Toner Correctly	The waste toner bottle is not set correctly, or is not set.	Set the waste toner bottle correctly.
Reset Yellow Toner Correctly	The toner cartridge (Y) is not set correctly or is not set, and the color printing is non-applicable.	Set the toner cartridge (Y) correctly. See " <i>Setting Up</i> " in the Setup Guide.
RPCS Graphic Error	The graphic is not initialized because the graphic memory was not reserved.	Replace the installed memory.
RPCS Memory Overflow	The printer memory is not initialized because the CDC memory was not reserved via the system call.	Replace the installed memory.
RPCS Syntax Error	The printer identified a syntax error. This error results from; data transmogrification caused by the transmission path problem, data interruption, data transmission from other drivers, etc.	Be sure to use the correct driver.

Messages/Second messages	Description	Solution
SC XXX-X Power Off On /If Error Reoccur Call Service	The Service Code or SC number indicates the problem.	Turn the power switch off and then on. If the message appears again, contact your sales or service representative.
Staple Cancelled	The Staple feature has been cancelled.	Verify that the paper orientation and layout is property set, and make sure whether your desired settings for the finisher is selected.
Toner is Almost Empty: Black	The printer is almost out of toner (K).	Prepare a new toner cartridge (K).
Toner is Almost Empty: Cyan	The printer is almost out of toner (C).	Prepare a new toner cartridge (C).
Toner is Almost Empty: Magenta	The printer is almost out of toner (M).	Prepare a new toner cartridge (M).
Toner is Almost Empty: Yellow	The printer is almost out of toner (Y).	Prepare a new toner cartridge (Y).
Waste Toner is Almost Full (E)	The waste toner bottle is almost full of toner dust.	Prepare a new waste toner bottle or contact your sales or service representative. See p.107 "Consumables".

Printer Does Not Print

Possible Cause	Solutions
Is the power on?	Confirm that the cable is securely plugged into the power outlet and the printer. Turn on the power switch.
Does the Online indicator stay on?	Press [On Line] so the indicator lights.
Does the Error indicator stay red?	Check the error message on the panel display and take the required action.
Is paper loaded?	Load paper into the paper tray or on the bypass tray. See p.47 "Paper and Other Media Supported by This Printer".
Can you print a configuration page?	If you cannot print a configuration page, it probably indicates a printer malfunction. You should contact your sales or service representative. See "Printing a Configuration Page" in Administrator Reference 2.
Is the interface cable connecting the printer to the computer connected securely?	Connect the interface cable properly. If there are any connectors or screws, confirm that they are fastened securely.
Are you using the correct interface cable?	The type of interface cable you should use depends on the computer. Be sure to use the correct one. If the cable is damaged or worn, replace it with a new one. See "Appendix" in Administrator Reference 2.

Possible Cause	Solutions
<p>Is the Data In indicator blinking or lit after starting the print job?</p>	<p>If not blinking or lit, the data is not being sent to the printer.</p> <ul style="list-style-type: none"> ◆ If the printer is connected to the computer using the interface cable Make sure the following printer port settings are correct: <ul style="list-style-type: none"> • For a parallel port connection, port LPT1 or LPT2 should be set. • For a IEEE 1394 (SCSI print) port connection, port 1394_00(n) *1 should be set. *1 (n) is the number of printers connected. • Windows 95/98/Me <ol style="list-style-type: none"> ① Click [Start], point to [Settings] and then click [Printers]. ② Click to select the icon of the printer. Next, on the [File] menu, click [Properties]. ③ Click the [Details] tab. ④ Check the [Print to the following port] box to confirm that the correct port is selected. • Windows 2000 <ol style="list-style-type: none"> ① Click [Start], point to [Settings] and then click [Printers]. ② Click to select the icon of the printer. Next, on the [File] menu, click [Properties]. ③ Click the [Port] tab. ④ Check the [Print to the following port] box to confirm that the correct port is selected. • Windows XP <ol style="list-style-type: none"> ① Access the [Printers and Faxes] window from [Start] on the taskbar. ② Click to select the icon of the printer. Next, on the [File] menu, click [Properties]. ③ Click the [Port] tab. ④ Check the [Print to the following port(s)] box to confirm that the correct port is selected. • Windows NT 4.0 <ol style="list-style-type: none"> ① Click [Start], point to [Settings] and then click [Printers]. ② Click to select the icon of the printer. Next, on the [File] menu, click [Properties]. ③ Click the [Port] tab. ④ Check the [Print to the following port] box to confirm that the correct port is selected.

Possible Cause	Solutions
When you use 1394 Interface Unit Type1045	<p>❖ Network Connection Contact your network administrator.</p> <ol style="list-style-type: none"> ① Confirm that the 1394 Interface Unit Type1045 is attached to the computer correctly. ② Confirm that the IEEE1394 interface cable is connected securely. ③ Restart the computer. If the error occurs even after executing above operation, proceed to the following steps. ④ Unplug the IEEE1394 interface cable which is connected to the printer. ⑤ Execute the utility tool for 1394 Interface Unit Type1045 which is stored in the following path in the CD-ROM labeled "Printer Drivers and Utilities". <p>UTILITY\1394</p> <p>Important</p> <p><input type="checkbox"/> For details about using the utility tool for IEEE1394, see the README file in the same directory in the CD-ROM.</p>

Other Printing Problems

4

Status	Possible Causes, Descriptions, and Solutions
Black gradation is not natural.	<ul style="list-style-type: none"> • PCL 5c/PostScript Select "CMY+K" for Gray Reproduction in the printer driver's [Advanced] dialog box under the [Print Quality] tab. • RPCS Select "CMY+K" for Gray Reproduction under the [Image Adjustments] tab in the printer driver's [Change Use Setting] dialog box.
Color documents are printed in black and white.	<p>The printer driver is not set up for color printing.</p> <ul style="list-style-type: none"> • PCL 5c/PostScript Select "Color" for the Color/Black and White under the printer driver's [Setup] tab. • RPCS Select "Color" for the Color/Black and White under the printer driver's [Print Settings] tab. <p>For more information, see the printer driver's Help file.</p> <p>Some applications normally print color text as black and white.</p>
Fine dot pattern does not print.	<ul style="list-style-type: none"> • PCL 5c/PostScript Change [Dithering] setting in the Advanced dialog box under the printer driver's [Print Quality] tab. • RPCS Change [Dithering] setting under the [Image Adjustments] tab in the [Change User Settings] dialog box under the [Print Quality] tab in the printer driver's dialog box. <p>For more information, see the printer driver's Help file.</p>
Images are cut off, or excess pages are printed.	<p>You might be printing on paper smaller than the paper size selected in the application. Use paper the same size as that selected in the application. If you cannot load paper of the correct size, use the reduction function to reduce the image, and then print.</p> <p>See the printer driver's Help file.</p>

Status	Possible Causes, Descriptions, and Solutions
It takes too much time to complete the print job.	<p>Photographs and other data intensive pages take a long time for the printer to process, so simply wait when printing such data.</p> <p>Changing the following settings may help to speed up printing.</p> <ul style="list-style-type: none"> • PCL 5c Select "600×600 dpi" for Resolution under the [Print Quality] tab in the printer driver's dialog box. • PostScript Select "1200×600 dpi" or "600×600 dpi" for Resolution under the [Print Quality] tab in the printer driver's dialog box. Select "Post Script(optimize for speed)" for PostScript output format under the [PostScript] tab in the printer driver's dialog box. • RPCS Select "1200×600 dpi" or "600×600 dpi" for Resolution under the [Image Adjustments] tab in the Change Use Settings dialog box in the printer dialog box. Select "Speed" for Print priority under [Print Quality] tab in the printer driver's dialog box. <p>For more information, see the printer driver's Help file.</p> <p>The data is so large or complex that it takes time to process it. If the Data In indicator is blinking, the data processing is being done. Just wait until it resumes.</p> <p>If "Warming Up..." appears on the panel display, the printer is now warming up. Wait for a while.</p> <p> Note</p> <p><input type="checkbox"/> To maintain the best quality, color adjustment is executed regularly during printing or after printing. Even if printing is not specified, color adjustment is sometimes executed regularly when the power is on.</p>
It takes too much time to resume printing.	<p>The data is so large or complex that it takes time to process it. If the Data In indicator is blinking, the data processing is being done. Just wait until it resumes.</p> <p>The printer might be set to the Energy Saver mode. In the Energy Saver mode, the printer has to warm up, and this takes time until printing starts. To cancel the Energy Saver mode, select "Off" for "Energy Saver 1" in the System Settings menu.</p>
Multiple pages are fed through the printer at once.	<p>Paper misfeeds easily when the Paper Feed Roller is dirty. Contact your sales or service representative to replace the Paper Feed Roller.</p>

Status	Possible Causes, Descriptions, and Solutions
<p>Output are not delivered to the selected tray you require.</p>	<p>When using the bypass tray, the size selected on the display panel might be different from actual paper size. Select the correct paper size. See p.47 "Paper and Other Media Supported by This Printer".</p>
	<p>When you are using a Windows operating system, the printer driver settings override those set using the control panel. Set the desired output tray using the printer driver. See the printer driver's Help file.</p>
<p>Paper misfeeds occur frequently.</p>	<p>Check that the side guide of the Paper Tray is locked. See p.47 "Paper and Other Media Supported by This Printer".</p> <p>The paper size and feed direction of the paper in the Bypass Tray might not be the same as those you selected with the control panel. Check the settings on the control panel, and load paper of the correct paper size and feed direction. See p.47 "Paper and Other Media Supported by This Printer".</p> <p>Check that the paper guide of the Paper Tray is attached properly.</p>
<p>Solid areas, lines or text are shiny or glossy when created as a mixture of cyan, magenta, yellow.</p>	<ul style="list-style-type: none"> • PCL 5c/PostScript Select "K(Black)" for Gray Reproduction in the printer driver's [Advanced] dialog box under the [Print Quality] tab. • RPCS Select "K(Black)" for Gray Reproduction under the [Image Adjustments] tab in the printer driver's [Change Use Setting] dialog box.
<p>Solid lines are printed as broken lines.</p>	<ul style="list-style-type: none"> • PCL 5c/PostScript Change the [Dithering] setting in the Advanced dialog box under the printer driver's [Print Quality] tab. • RPCS Change the [Dithering] setting under the [Image Adjustments] tab in the [Change User Settings] dialog box, under the [Print Quality] tab in the printer driver's dialog box. For more information, see the printer driver's Help file.
<p>Some parts of the print image are not clear.</p>	<p>Make the image density darker. To adjust the image density, press [Menu] on the control panel, and select Image Density from the Maintenance menu.</p>
<p>The color of the printout is different from the color on the computer's display.</p>	<p>The toner based color settings with the printer driver causes a drastic change in printout color.</p>
	<p>Changing the color settings with the printer driver causes a drastic change in printout color. See the printer driver's Help file.</p>

Status	Possible Causes, Descriptions, and Solutions
The image is printed in the wrong orientation.	The feed direction you selected and the feed direction selected in Option Setup of the printer driver might not be the same. Make the proper settings.
The control panel error message stays on after removing the mis-fed paper.	Open the front cover of the printer, and then close it.
The print image is not clear.	Due to a sudden change in temperature, condensation might appear inside the printer, reducing print quality. If this occurs, when you move the printer from a cold room to a warmer room, do not use the printer until it acclimatizes to the temperature.
The print side of the page is a hazy gray.	Adjust the image density. To adjust the image density, press [Menu] , and select Image Density from the Maintenance menu. See p.31 "Cleaning and Adjusting the Printer".
	If paper is curled, correct it. Curled or folded paper might cause a hazy gray print. Curling often occurs on postcards, so be sure to correct it before printing.
The printed image is different from the image on the computer.	When you use some functions, such as enlargement and reduction, the layout of the image might be different from that displayed in the computer display.
	You might have selected to replace True Type fonts with printer fonts in the printing process. To print an image similar to the image on the computer, make the settings to print out True Type fonts as an image. See the printer driver's Help file.
The printer does not print at 1200dpi, even if 1200dpi resolution is selected.	Printing at 1200dpi uses much memory. Therefore, depending on the memory capacity, you may not be able to print at 1200dpi. Either add memory to the printer, or reduce the size of data to be printed. See "Memory Capacity and Paper Size" in Administrator Reference 2.
There are color differences in the color documents.	Press [Menu] , and select "Color Regist." from the "Maintenance" menu. See p.31 "Cleaning and Adjusting the Printer".

 **Note**

- If the problem cannot be solved, contact your sales or service representative.

Removing Misfed Paper

If a paper misfeed occurs, an error message appears indicating the location of the misfed paper on the panel display. This printer has the auto-recovery function, by which misfed paper is sent to the Standard Tray or Right Cover. Usually, you can remove the misfed paper easily with this function.

4

Detaching the 2 Tray Finisher

There are times when you might have to detach the 2 Tray Finisher from the printer to remove misfed paper. This section describes how to detach the 2 Tray Finisher.

- 1** Hold the handle at the top of the 2 Tray Finisher firmly with one hand, pull the 2 Tray Finisher straight out, and let go when it stops.

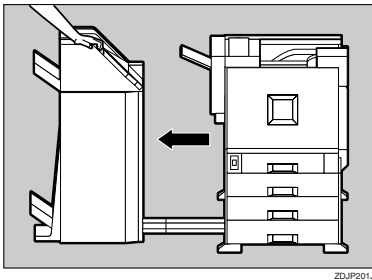

The 2 Tray Finisher is detached from the printer.

- 2** Use both hands to push it straight back in, and let go when it clicks into place.

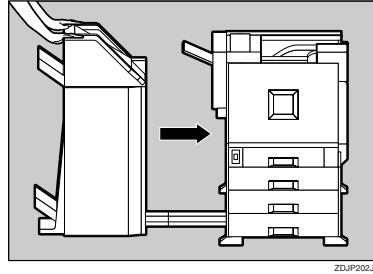

The 2 Tray Finisher is reattached to the printer.

Important

- Attach the 2 Tray Finisher to the printer after closing the Duplex Reversal Unit.

Opening and Closing the Duplex Reversal Unit

There are times when you might have to detach the Duplex Reversal Unit to remove misfed paper. This section describes how to detach the Duplex Reversal Unit.

- 1 Push up the lock release button and keep it in place.

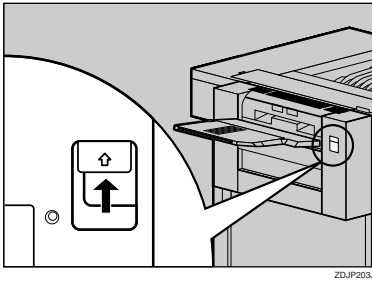

ZDJP203J

- 2 Lower the Duplex Reversal Unit slowly until it stops.

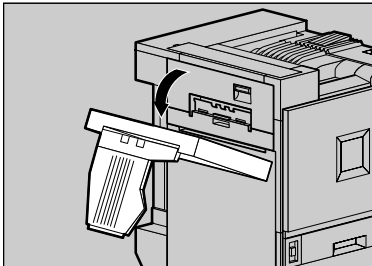

ZDJP204J

Important

- ❑ Open the Duplex Reversal Unit after detaching the 2 Tray Finisher from the printer.

Note

- ❑ You do not have to remove the output tray even if the 2 Tray Finisher is attached.

The Duplex Reversal Unit is opened.

- 3 Raise the Duplex Reversal Unit slowly with both hands, and push it in until it clicks into place.

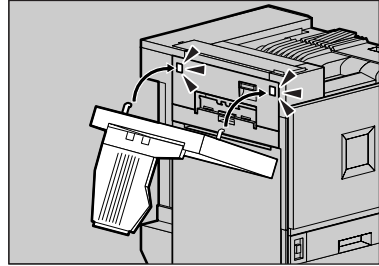

ZDJP205J

The Duplex Reversal Unit is closed.

Important

- ❑ Attach the Duplex Reversal Unit after closing the upper left cover for the printer.

Removing Misfed Paper in the Duplex Feed Unit

You can remove misfed paper from the Duplex Feed Unit following the procedure below.

Note

- ❑ When a paper misfeed occurs in the Duplex Feed Unit, the printer usually sends the misfed paper to the right cover and there is no need to execute following procedure. See p.92 "When "Remove Misfeed A:Internal Path" Appears".

Important

- ❑ Be sure to remove a misfed paper following the procedure below, only when "Remove Misfeed: Dup. Feed Unit" appears on the panel display.

1 Turn off the power switch and unplug the power cable.

2 Open the front cover slowly by pulling down from the two areas on the left and right.

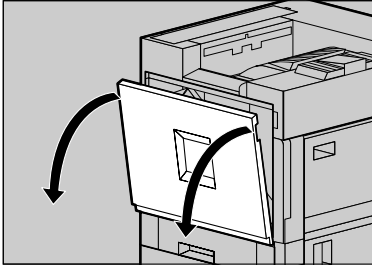

ZD.JH007J

3 Take out the green screwdriver.

Use this screwdriver for all attachment and detachment of screws.

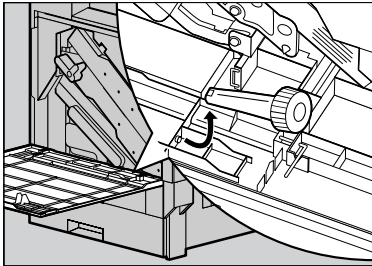

ZD.JH013J

4 Remove the screw that is fastening the Duplex Feed Unit using provided screwdriver.

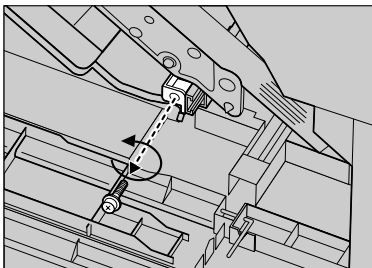

ZD.JP221J

You will use this screw to refasten the Duplex Feed Unit later.

5 Pinch the upper left area of the Duplex Feed Unit, and pull it out slowly halfway.

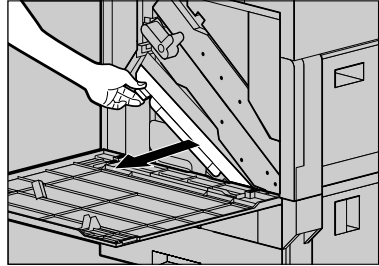

ZD.JP213J

6 Holding the Duplex Feed Unit firmly with both hands, pull it straight out.

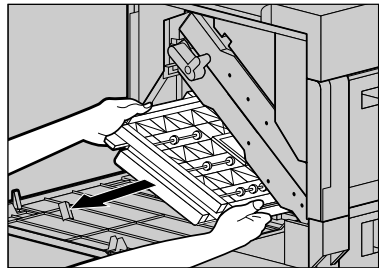

ZD.JP214J

7 Place the Duplex Feed Unit on the floor slowly. Open it slowly, and remove the misfed paper.

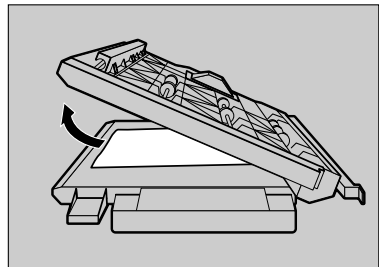

ZD.JP215J

Important

- Do not open the Duplex Feed Unit by force. It might damage the unit.

8 Close the Duplex Feed Unit.

9 Holding the Duplex Feed Unit with both hands, insert it along the rails slowly until it stops.

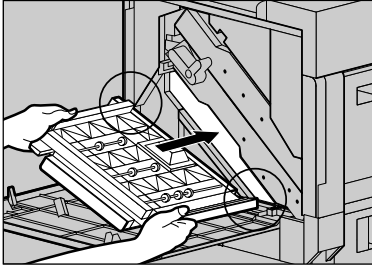

ZDJP056J

The top and bottom rails are located in the position shown in the illustration.

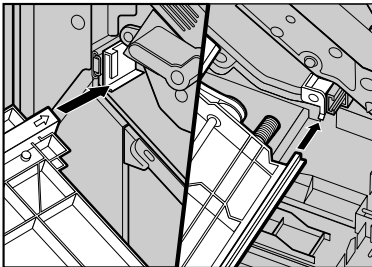

ZDJP133J

There are two arrows located on the left and right sides of the Duplex Feed Unit.

10 Refasten the Duplex Feed Unit using provided screwdriver. Use the screw that was removed in step **4**.

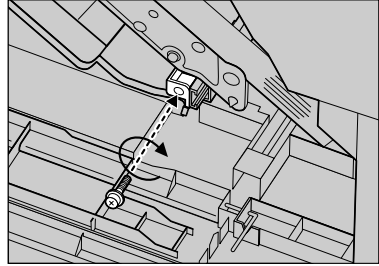

ZDJP057J

Note

- Be sure to return the provided screwdriver to its original position on the inside of the front cover.

11 Close the front cover slowly by pushing the two areas on the left and right.

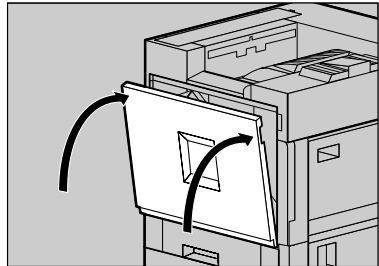

ZDJH041J

12 Plug in the power cable and turn on the power switch.

When "Remove Misfeed A: Internal Path" Appears

1 Open the right cover.

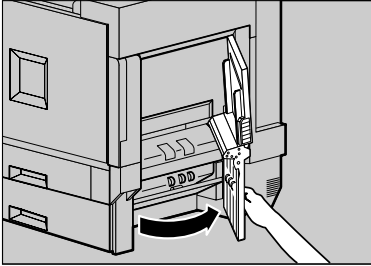

2 Move the blue lever up and down to feed the misfed paper, and then pull out the paper slowly.

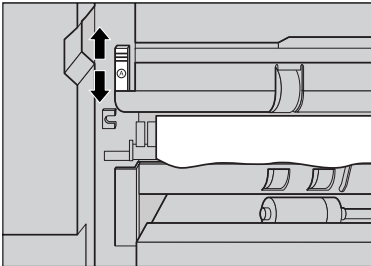

3 Close the right cover by pushing the area labeled "PUSH".

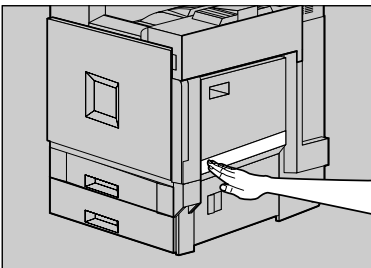

When "Remove Misfeed B: Fusing Unit" Appears

CAUTION:

- The inside of the machine becomes very hot. Do not touch the parts with a label indicating a "hot surface". Touching a "hot surface" could result in a burn.

1 If the 2 Tray Finisher is installed, detach it from the printer.

Reference

⇒ p.88 "Detaching the 2 Tray Finisher"

2 If the Duplex Unit is installed, open the Duplex Reversal Unit.

Reference

⇒ p.89 "Opening and Closing the Duplex Reversal Unit"

3 If the output tray is attached to the printer, raise it in the direction of the arrow (①), and remove it (②).

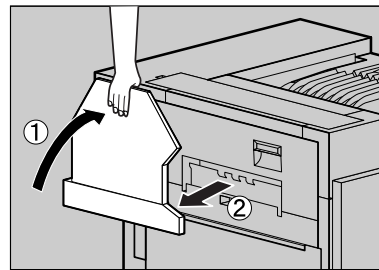

- 4** Pull out the upper left cover for the printer slowly.

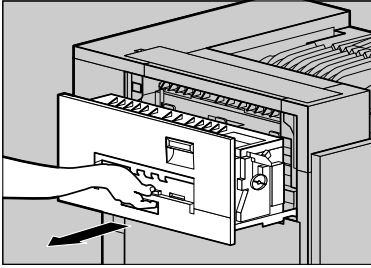

ZDJH047J

- 5** Open the upper left cover.

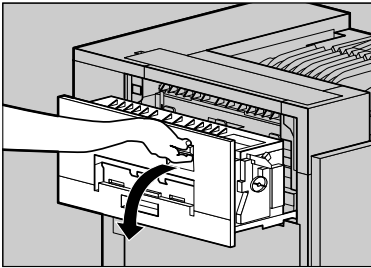

ZDJH048J

- 6** Turn the blue dial in the direction of the arrow to feed the misfed paper, and pull out the paper slowly.

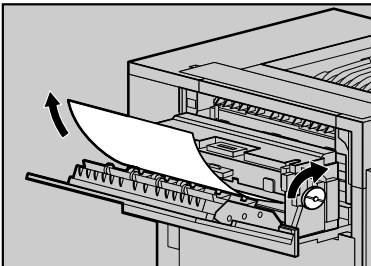

ZDJY206J

Important

- ❑ Always turn the blue dial in the direction of the arrow. If you turn it in the reverse direction, the paper feeds into the printer, making it difficult for you to take out the paper.
- ❑ Do not pull out the misfed paper. Use the blue dial to feed misfed paper.

- 7** Close the upper left cover (①) and push the handle slowly to the back until it clicks into place (②).

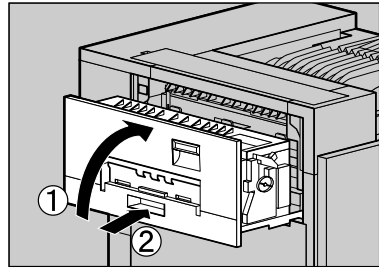

ZDJH051J

- 8** If you removed the output tray in step 3, reattach it to the printer. Insert the hooks of the output tray into the printer slits, and lower it toward you.

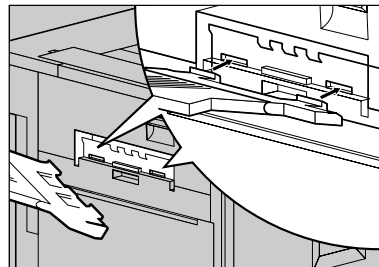

ZDJH010J

9 If the Duplex Unit is installed, close the Duplex Reversal Unit.

Reference

⇒ p.89 "Opening and Closing the Duplex Reversal Unit"

10 If the 2 Tray Finisher was installed, reattach the 2 Tray Finisher to the printer.

Reference

⇒ p.88 "Detaching the 2 Tray Finisher"

4

When "Remove Misfeed W: Mailbox" Appears

1 Open the Mailbox Cover slowly (①), pull out the misfed paper slowly (②).

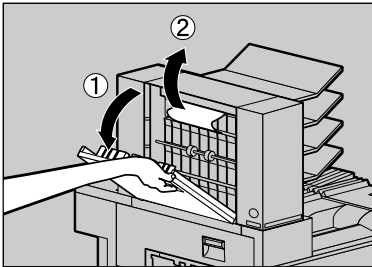

ZDJY207J

2 Close the Mailbox Cover.

When "Remove Misfeed R: Finisher" Appears

Open the top cover (①) and front cover (②) of the 2 Tray Finisher, and remove the misfed paper.

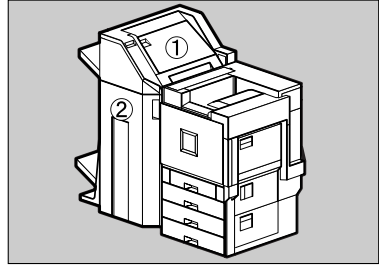

ZDJP206J

1 Fold the Output Tray.

1 Raise it vertically.

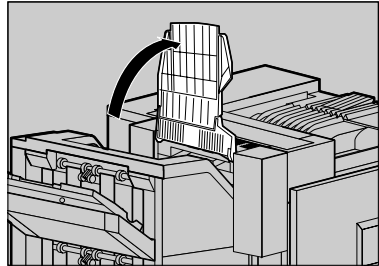

ZDJP207J

2 Fold it along the printer body.

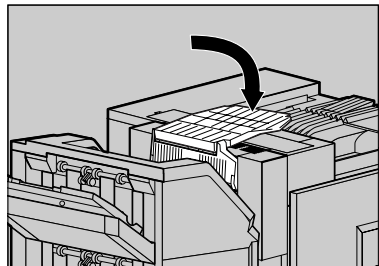

ZDJP208J

- 2** Open the top cover for the 2 Tray Finisher, and pull out the misfed paper slowly.

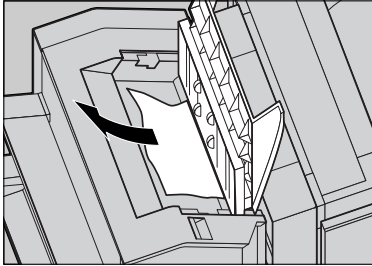

ZDJY208J

- 3** Close the top cover slowly.

- 4** Open the front cover for the 2 Tray Finisher.

Check to see if there is a misfed paper in areas A, B, C, and D.

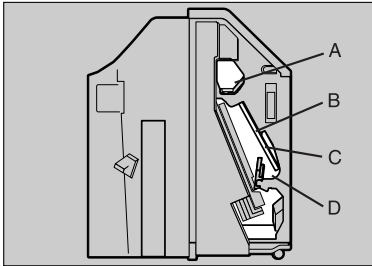

ZDJY209J

- 5** Check area A of step 4. Lift the lever (1), and while supporting it with your hand not to lower, pull out the misfed paper slowly.

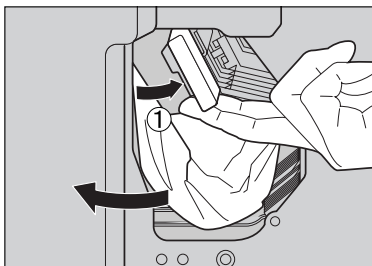

ZDJP210J

- 6** Lower the lever slowly to return it into place.

- 7** Check areas B and C of step 4. Lower the lever in the direction of the arrows (1), and pull out the misfed paper slowly.

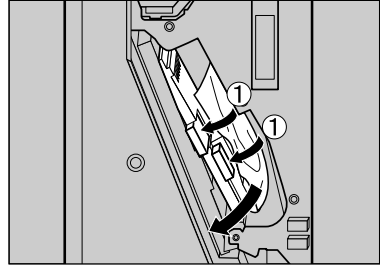

ZDJP211J

- 8** Lift the lever slowly to return it into place.

- 9** Check area D of step 4. Lift the lever in the direction of the arrow (1), and pull out the misfed paper slowly.

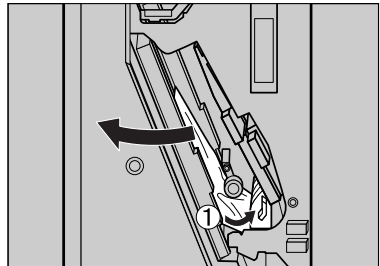

ZDJP212J

- 10** Lower the lever slowly to return it into place.

4

11 Close the front cover for the 2 Tray Finisher.

If the error message does not clear even after the misfed paper is removed, detach the 2 Tray Finisher from the printer to check for the misfed paper there.

Reference

See p.88 "Detaching the 2 Tray Finisher" for details about how to detach/reattach the 2 Tray Finisher from/to the printer.

4

12 Return the Output Tray back into place.

1 Raise the tray.

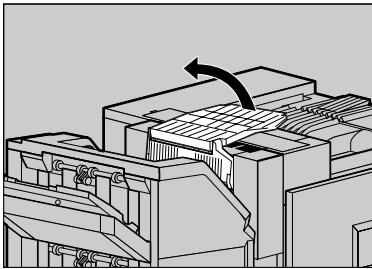

ZDJF086J

2 Lower it slowly.

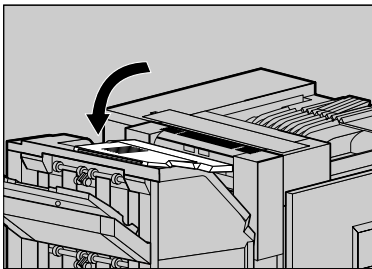

ZDJF086J

When "Remove Misfeed Y: Paper Tray" Appears

1 Open the Lower Right cover for the Paper Feed Unit, and pull out the misfed paper.

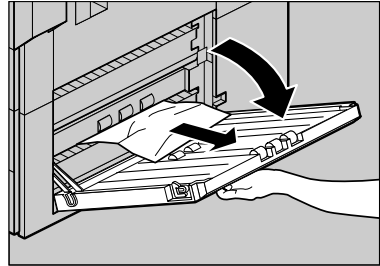

ZDJY209J

2 Close the Lower Right cover for the Paper Feed Unit.

When "Remove Misfeed :Duplex Unit " Appears

CAUTION:

- The inside of the machine becomes very hot. Do not touch the parts with a label indicating a "hot surface". Touching a "hot surface" could result in a burn.

1 If the 2 Tray Finisher is installed, detach it from the printer.

Reference

⇒ p.88 "Detaching the 2 Tray Finisher"

- 2** Open the left cover for the Duplex Reversal Unit, and remove the misdied paper. Do not pull the paper out by force.

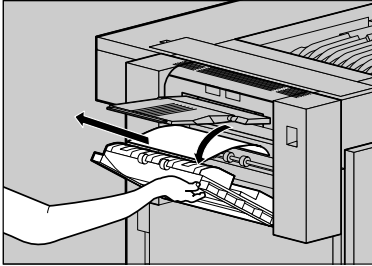

If you cannot remove the paper, proceed to step **3**.

- 3** Push up the lock release button for the Duplex Reversal Unit, and then hold it in place.

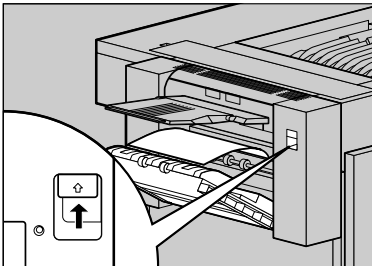

- 4** Lower the Duplex Reversal Unit slowly until it stops, and remove the misdied paper.

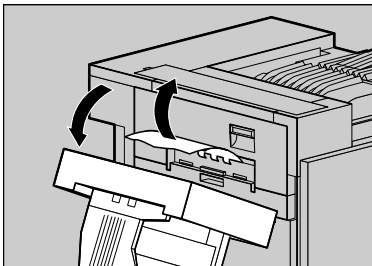

- 5** Raise the Duplex Reversal Unit slowly and insert until it clicks into place. Raise the left cover, and close it securely by pushing the area labeled "PUSH".

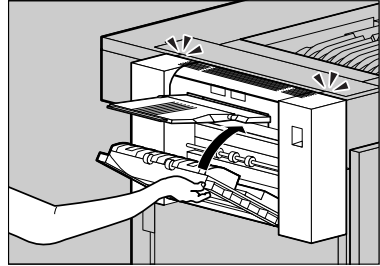

Removing Jammed Staples

When "Add Staples " appears on the panel display, or when the printer does not staple even after it is instructed to, the staples might be jammed.



- 1** Open the front cover for the 2 Tray Finisher.

The stapler is attached to the position shown in the illustration.

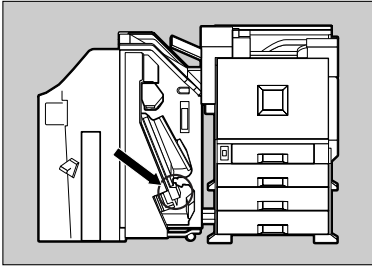

ZDJP216J

- 2** Remove the cartridge by pulling the green knob in the direction of the arrow.

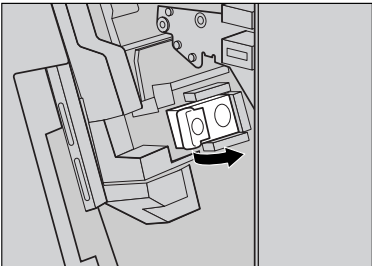

ZDJP217J

- 3** Open the face plate of the cartridge to unlock it.

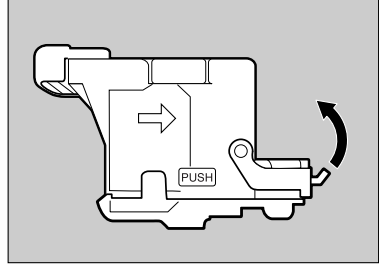

ZDJP227J

- 4** Remove the jammed staples.

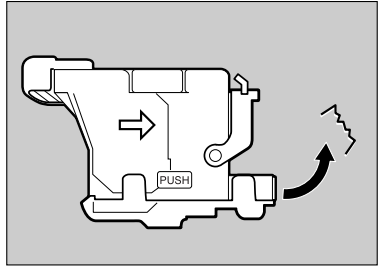

ZDJP228J

- 5** Close the face plate of the cartridge until it clicks into place.

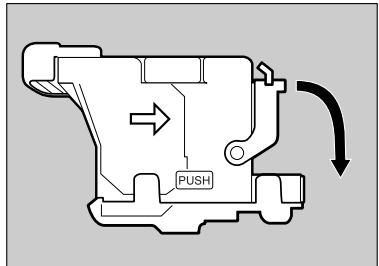

ZDJP229J

- 6** Slant and insert the cartridge (①), and push in until it clicks into place (②).

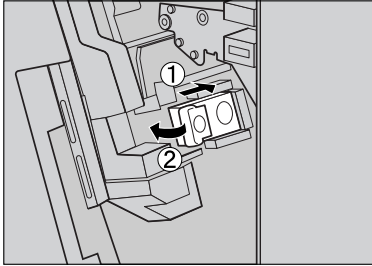

ZDUP218J

- 7** Close the front cover for the 2 Tray Finisher.

Adding Staples

When "Add Staples " appears on the panel display, add a new staple refill.



- 1** Open the front cover for the 2 Tray Finisher.

The stapler is attached to the position shown in the illustration.

4

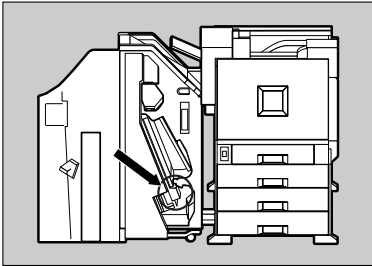

ZDJP216J

- 2** Remove the cartridge by pulling the green knob in the direction of the arrow.

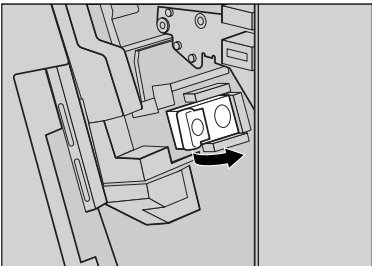

ZDJP217J

- 3** Push the areas labeled "PUSH", located on both sides of the stapler.

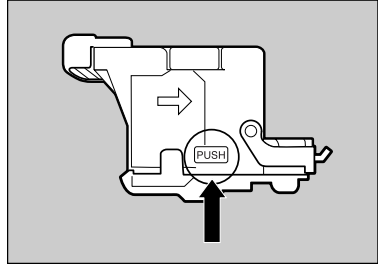

ZDJP223J

The case cover at top floats up.

- 4** Pull the case cover up.

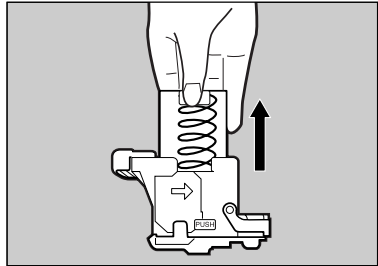

ZDJP223J

- 5** Hook your finger in the hole of the empty refill case to pull it out.

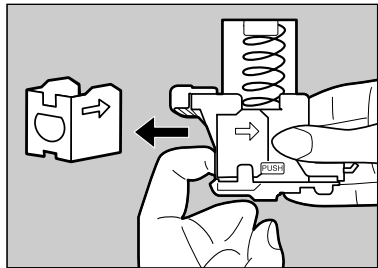

ZDJP224J

- 6** Push in until the arrow on the refill case lines up with the arrow on the refill case cover.

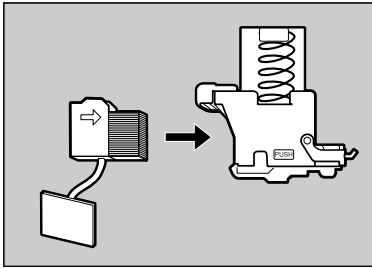

ZDJP225J

- 9** Slant and insert the cartridge (①), and push in until it clicks into place (②).

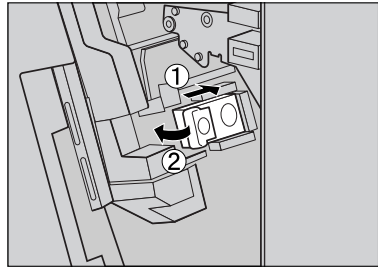

ZDJP218J

- 7** Push the case cover down until it clicks into place.

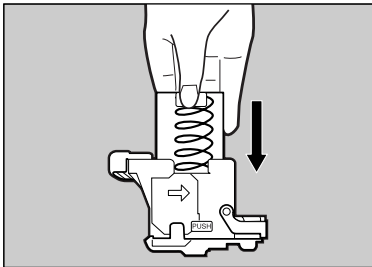

ZDJP230J

- 10** Close the front cover for the 2 Tray Finisher.

4

- 8** Pull out the ribbon used for bundling the staples.

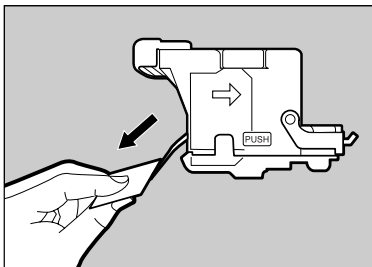

ZDJP226J

 **Note**

- Remove the entire length of the ribbon.

Removing Punch-hole Chips

When "Punch-hole Chips are Full" appears on the panel display, the punch waste box is full. Follow these steps to remove paper chips.

Note

- ❑ Same message appears when the punch waste box is not installed correctly.



4

1 Open the front cover for the 2 Tray Finisher.

The punch waste box is attached to the position shown in the illustration.

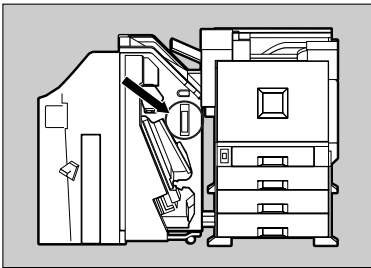

ZDJIP219J

2 Pull out the punch waste box and remove the paper chips.



ZDJIP220J

3 Re-install the punch waste box.

4 Close the front cover for the 2 Tray Finisher.

When the message appears even after removing the Punch-hole chips

When the "Punch-hole Chips are Full" message appears on the control panel even the punch waste box is not full, punch-hole chips might be stuck around the punch waste box hole as shown in the illustration. Remove the punch-hole chips around the hole.

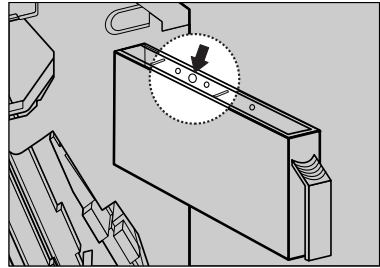

ZBGH030N

5. Appendix

When the Front Cover Does Not Close

When "Close Front Cover" appears on the panel display, even if the cover seems to be closed properly, it is not.



When the front cover does not close, confirm that the Transfer Unit is attached firmly.

The Transfer Unit is attached to the position shown in the illustration.

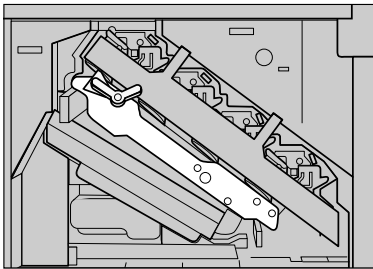

ZD.JH995J

1 Turn off the power switch and unplug the power cable.

2 If the light brown lever is in the position shown in the illustration, turn it counterclockwise.

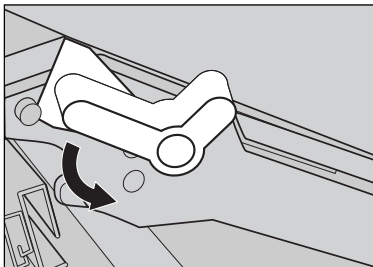

ZD.JH014E

3 Push in the Transfer Unit until it stops.

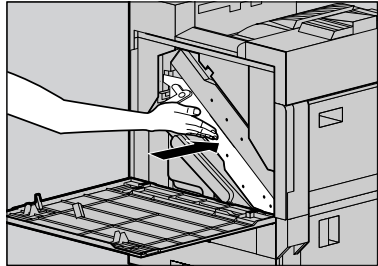

ZD.JH999J

Confirm that the protrusion inside the printer is in the upper left hole of the Transfer Unit.

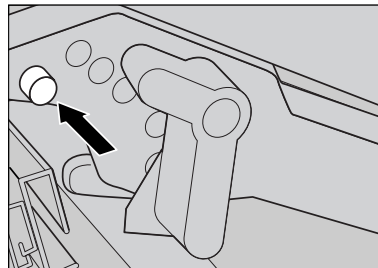

ZD.JH992J

4 Turn the light brown lever clockwise.

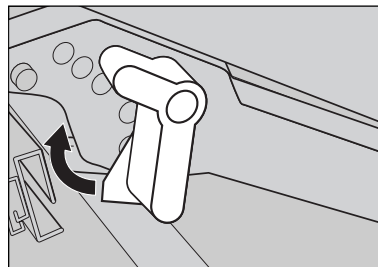

ZD.JH020E

- 5** Close the front cover slowly by pushing the two areas on the left and right.

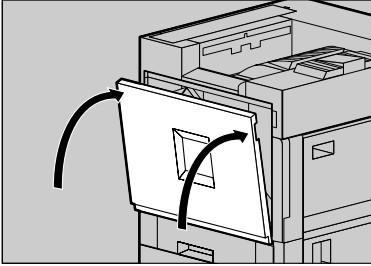

ZD.JH041.J

- 6** Plug in the power cable and turn on the power switch.

5

Moving and Transporting the Printer

CAUTION:

- *When moving the machine, each person should hold the handle, where two are located on opposite sides, and lift slowly. Lifting it carelessly or dropping it may cause an injury.*
- *When you move the printer, remember to unplug the power cord from the wall outlet to avoid a fire or an electric shock.*
- *When you pull out the plug from the socket, grip the plug to avoid damaging the cord and causing a fire or an electric shock.*

Note

- The printer weighs approximately 83 kg.

Repack the printer in its original packing materials for transporting.

Important

- Be sure to disconnect all cables from the printer before transporting it.
- The printer is a precision piece of machinery. Take care to avoid damage during shipment.

5

Moving the Printer

CAUTION:

- *When lifting the machine, use the inset grips on both sides. Otherwise the printer could break or cause injury if dropped.*
- *Before moving the machine, unplug the power cord from the outlet. If the cord is unplugged abruptly, it could become damaged. Damaged plugs or cords can cause an electrical or fire hazard.*

Note

- The machine weighs is about 83 kg.

Moving the printer in the short distance

1 Be sure to check the following points:

- The power switch is turned off.
- The power cable is unplugged from the wall outlet.
- The interface cable is unplugged from the printer.

2 If you have installed external options, remove them.

3 Be sure to close the bypass tray and the front cover.

4 Lift the printer and move it horizontally to the place where you want to install it.

Important

- Be sure to move the printer horizontally. Moving the printer slowly avoiding the toner to scatter.
- If the Paper Feed Unit(s) is installed, detach it and move the printer separately.

Consumables

CAUTION:

- *Our products are engineered to meet the highest standards of quality and functionality. When purchasing expendable supplies, we recommend using only those specified by an authorized dealer.*

◆ **Toner cartridge**

Toner cartridge	Average printable number of pages per cartridge ^{*1}
Cyan	10,000 pages
Magenta	10,000 pages
Yellow	10,000 pages
Black	20,000 pages

^{*1} A4 5% test chart, 5 pages/job

Note

- The actual number of printed pages you get from a particular toner cartridge depends on the type and size of paper you are using, the contents of your print images, and printing environment conditions. All this means that a toner cartridge might require replacement sooner than the normal life described above.
- Toner cartridges that come with the printer are for setup purposes, and will not provide the number of pages described above. The average number of printable pages that can be expected from the toner cartridges included in the printer are as follows:
 - Black toner cartridge : about 10,000 pages
 - Cyan, magenta and yellow toner cartridges : about 5,000 pages for each cartridge.

◆ **Staple Cartridge**

Cartridge type	Number of shots
Staple cartridge	5000 shots × 1 with cartridge
Staple Refill cartridge	Refill 5000 shots × 3

◆ Other consumables

Note

- Actual life of consumables depends on the type and size of paper you are using, the contents of your print images, and printing environment conditions. All that means that consumables might require replacement sooner than the life indicated. Furthermore, the life of color consumables may considerably shorten as mixed printing of black & white pages and color pages frequently occurs.

Name	Consumables	Average printable number of pages ^{*1}
Printer Maintenance Kit Type 3800A	Color Photoconductor Unit × 3	50,000 pages ^{*2}
Printer Maintenance Kit Type 3800B	Color Development Unit × 3	100,000 pages ^{*2}
Printer Maintenance Kit Type 3800C	Fusing Unit × 1	100,000 pages ^{*2}
Printer Maintenance Kit Type 3800D	Black Development Unit × 1	100,000 pages ^{*2}
Printer Maintenance Kit Type 3800E	Waste Toner Bottle × 1	50,000 pages
Printer Maintenance Kit Type 3800F	Black Photoconductor Unit × 1	50,000 pages ^{*2}
Printer Maintenance Kit Type 3800G	Fuser Oil Unit × 1	20,000 pages ^{*2}
Printer Maintenance Kit Type 3800H	Paper Feed Rollers × 1	150,000 pages

^{*1} A4 5% test chart, 5 pages/job

^{*2} When printing each page as a single job, the unit needs extra idling, thus reducing the unit's print life by half.

INDEX

A

- Adding Staples, 100
- Adjusting the Color Registration, 34
 - Auto Adjust*, 34
 - Manual Adjust*, 39
- Adjusting the Image Density, 43
- Adjusting the Registration of the Trays, 44
- Appendix, 103

B

- Bypass Tray
 - Custom Size*, 66
 - Paper Type*, 67

C

- Caution, ii
- Cleaning the DustProof Glass, 33
- Cleaning the Registration Roller, 32
- Clearing and Adjusting the Printer, 31
- Color Adjustment
 - Checking the Test Sheet*, 41
- Consumables, 107

D

- Data In indicator, 82
- Detaching the 2 Tray Finisher, 88
- Detaching the SR770 (2 Tray Finisher), 1
- Display panel, messages, 69

E

- Energy Star, iv
- Envelopes, 55
- Error, 69
- Error indicator, 81

L

- Loading Paper, 53, 58
 - Optional Paper Feed Unit*, 59
 - Tray 1*, 58
 - Tray 2*, 59
- Loading paper
 - Bypass Tray*, 64
 - Paper Bank PS470*, 60
 - paper size*, 61
 - paper type*, 63

M

- messages, 69
- Moving the Printer, 105

O

- OHP transparencies, 54
- Online indicator, 81
- Online key, 81
- Opening and Closing the Duplex Reversal Unit, 2, 89
- Other Printing Problems, 84

P

- Paper and Other Media, 47
- Paper Size, 47
- Plain Paper, 54
- Printable Area, 57
- Printer Does Not Print, 81

R

Remove Misfed Paper

Duplex Unit, 96

Finisher, 94

Fusing Unit, 92

Internal Path, 92

Mailbox, 94

Paper Tray, 96

Removing Jammed Staples, 98

Removing Misfed Paper, 88

Removing Misfed Paper into the Duplex
Feed Unit, 89

Removing Punch-hole Chips, 102

Replacing Consumables and Maintenance Kit, 1

Replacing the Development Unit, 15

Replacing the Dustproof Filter, 24

Replacing the Fuser Oil Unit, 6

Replacing the Fusing Unit, 19

Replacing the Photoconductor Unit, 10

Replacing the Toner Cartridge, 3

Replacing the Waste Toner Bottle, 26

S

Storing Paper, 53

T

Thick Paper, 54

Toner Cartridge, 107

Troubleshooting, 69

W

Warning, ii

When the Front Cover Does Not Close, 103

MEMO

MEMO



RICOH COMPANY, LTD.

15-5, Minami Aoyama 1-chome,
Minato-ku, Tokyo 107-8544, Japan
Phone: +81-(0)3-3479-3111

Overseas Affiliates

U.S.A.

RICOH CORPORATION
5 Dedrick Place
West Caldwell, New Jersey 07006
Phone: +1-973-882-2000

The Netherlands

RICOH EUROPE B.V.
Groenelaan 3, 1186 AA, Amstelveen
Phone: +31-(0)20-5474111

United Kingdom

RICOH UK LTD.
Ricoh House,
1 Plane Tree Crescent, Feltham,
Middlesex, TW13 7HG
Phone: +44-(0)20-8261-4000

Germany

RICOH DEUTSCHLAND GmbH
Mergenthalerallee 38-40,
65760 Eschborn
Phone: +49-(0)6196-9060

France

RICOH FRANCE S.A.
383, Avenue du Général de Gaulle
BP 307-92143 Clamart Cedex
Phone: +33-(0)-821-01-74-26

Spain

RICOH ESPAÑA S.A.
Avda. Litoral Mar, 12-14,
08005 Barcelona
Phone: +34-(0)93-295-7600

Italy

RICOH ITALIA SpA
Via della Metallurgia 12,
37139 Verona
Phone: +39-045-8181500

Hong Kong

RICOH HONG KONG LTD.
21/F., Tai Yau Building,
181, Johnston Road,
Wan Chai, Hong Kong
Phone: +852-2862-2888

Singapore

RICOH ASIA PACIFIC PTE.LTD.
260 Orchard Road,
#15-01/02 The Heeren,
Singapore 238855
Phone: +65-830-5888

Model number: Aficio AP3800C

Printed in The Netherlands

EE (GB) G060-6585B